

# Convolution's Performance in Amplify and Forward System with Predistortion and Relay Selection

Annisa Anggun Puspitasari<sup>1</sup>, Mareta Dwi Nor Habibah<sup>2</sup>, Ziyadatus Shofiyah<sup>3</sup>, Ida Anisah<sup>4</sup>, Yoedy Moegiharto<sup>5</sup>

**Abstract**—This paper evaluated the performance of the convolutional coding technique in a cooperative communication system using the amplify-and-forward (AF) protocol and applying a relay selection strategy by simulation. At the transmitter (source) side, a joint of peak average power ratio (PAPR) reduction techniques with selective mapping (SLM) schemes and the Hammerstein predistortion model was applied. The predistortion technique with the Rapp inverse model was applied at the relay. On the channel side, the relays were used as a virtual antenna, where relay usage in cooperative communication systems can be implemented for 4G or 5G networks in future research, even though it requires large bandwidth. Implementing the relay selection strategy can increase bandwidth efficiency because only the best relay will forward information from source to destination. The conventional relay selection strategy was used to evaluate the performance of the convolution coding in a multi-relay scheme by choosing the best relay considering the signal-to-noise ratio (SNR) value on the source to relay and relay to the destination channel. Only the best relay will forward the signal from source to destination using the AF protocol. System performance is expressed in bit error rate (BER) probability. The simulation results showed that the convolutional coding technique could improve system performance up to 16.59% with or without predistortion techniques. Then, the predistortion technique applied on the source and relay side generated the best performance, where the system performance could increase up to 34%. In addition, the implementation of the conventional relay selection strategy showed that the scheme with the most relays, which was six relays, could produce the best performance due to the increasing number of available paths.

**Keywords**—Convolutional Code, OFDM, Cooperative Communication, AF Protocol, Predistortion, Relay Selection.

## I. INTRODUCTION

Orthogonal frequency division multiplexing (OFDM) is a multicarrier modulation scheme that can produce high spectral efficiency, high data transmission, and is resistant to the multipath fading effects. OFDM systems have been widely applied to modern wireless communication systems, such as wireless local/metropolitan area network standards (WLAN/WMAN), European digital audio/video broadcasting (DAV/DVB), and long-term evolution (LTE). However, the

OFDM signal has a high peak to average power ratio (PAPR) value due to the coherent summation process of many multicarrier modulation signals. The high PAPR value is a fundamental weakness of the OFDM system. If the signal is transmitted to a nonlinear power amplifier, distortion will occur in the transmitted signal to reduce the system performance. To overcome this weakness, it is necessary to reduce the PAPR or adequate input back off (IBO) on the power amplifier's input signal. However, reducing the PAPR can correspondingly reduce the power amplifier efficiency, so an alternative solution is needed, namely increasing the linear area of the power amplifier and increasing system performance by applying the distortion technique [1]–[3].

Meanwhile, cooperative communication systems on wireless networks have become the subject or topic of world research [4], [5]. The cooperative communication system model is a relay model consisting of an information source, S, relays, and a destination receiver or destination, D. This transmission model has been proven capable of eliminating signal attenuation caused by the effects of wireless channels' multipath propagation. By involving a group of relays to work together in forwarding the signal received from the source, this transmission model can create a virtual multiantenna system, called a space diversity system. There are two primary protocols in this relay model diversity system, specifically the amplify-and-forward (AF) and decode-and-forward (DF) protocols. In the AF protocol, the relay receives a signal that has been distorted by the source-relay channel (SR line) from the information source S, then amplifies and forwards it to the destination. The performance of the AF protocol has been studied in previous studies [6], [7].

OFDM application in cooperative communication systems causes nonlinear distortion problems and nonlinear power amplifiers in transmitters. The effects of nonlinear distortion of nonlinear power amplifiers on relay transmitters has been previously investigated [8], [9]. Currently, a relay selection strategy is being developed to improve the performance of cooperative communication systems. The development of a relay selection strategy with the AF protocol has also been studied [10], [11]. Furthermore, research on the performance of the relay selection strategy with nonlinear distortion of the power amplifier is being implemented intensely. The performance of the AF protocol cooperative communication system and the relay selection strategy with a nonlinear power amplifier were investigated in [12]–[14]. All three papers did not apply channel coding for the information sources that could improve system performance toward the influence of multipath channels. In addition, the nonlinear distortion effect is solely induced by the nonlinear power amplifier on the transmitter side of the relay. This paper applied the convolutional model

<sup>1,2,3,4,5</sup> Telecommunication Engineering, Department of Electrical Engineering, Electronic Engineering Polytechnic Institute of Surabaya, Jalan Raya ITS, PENS Campus, Sukolilo, Surabaya 60111 (tlp: 031-5947280; fax: 031-5946111; e-mail: <sup>1</sup>annisanggun@gmail.com, <sup>2</sup>maretadwinh@gmail.com, <sup>3</sup>shofiyah.ziya18@gmail.com, <sup>4</sup>ida@pens.ac.id, <sup>5</sup>ymoegiharto@pens.ac.id)

[Received: 25 August 2021, Revised: 7 December 2021]

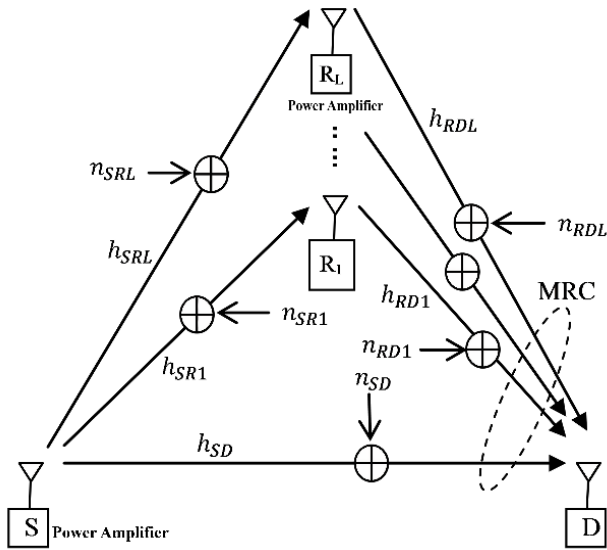

Fig. 1 Multi relay cooperative communication system.

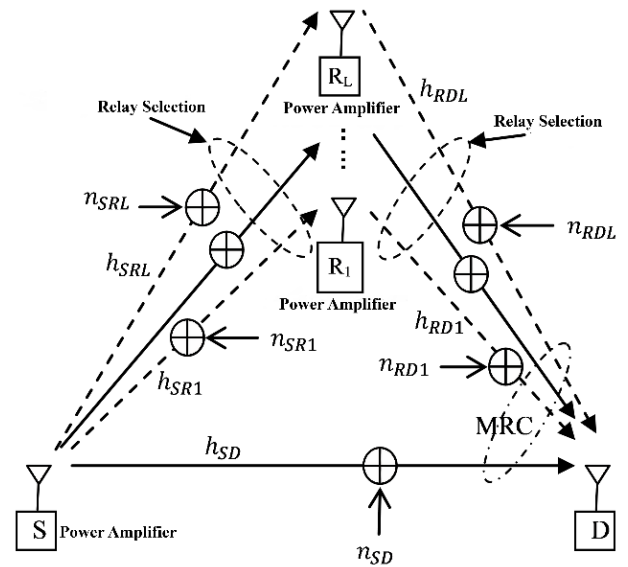

Fig. 2 Relay selection strategy in a cooperative communication system.

channel coding to the source’s information signal and the distortion technique’s application in the source transmitter and relay. A high power predistorter-amplifier cascade array with Hammerstein-Wiener model memory was applied in the source transmitter.

In contrast, a Rapp inverse predistorter and a nonlinear power amplifier without a Rapp memory model were applied in the relay transmitter. To reduce the PAPR value of the OFDM signal, a selective mapping (SLM) PAPR reduction technique was used at the transmitter [15]. It aims to reduce the amplitude of the OFDM signal to make the power amplifier operate in the linear region. System performance with the application of the convolutional code was manifested in the value curve or bit error rate (BER).

## II. SYSTEM MODEL

### A. Cooperative Communication System with AF Protocol

A basic cooperative communication system encompasses an information source (S), a destination receiver (D), and several half-duplex relays (R). Suppose each source, relay, and destination transmitter has one antenna, then the source transmitter and relay transmitter have a nonlinear power amplifier, the system block diagram can be shown in Fig. 1.

Channel state information (CSI) conditions on the source to relay, relay to destination, and source to destination channels are denoted as  $h_{SR}$ ,  $h_{RD}$ , and  $h_{SD}$ . Each of the three is considered as a complex Gaussian random variable that is independent and identically distributed (i.i.d.), while the mean value is zero and the variance value is  $\sigma^2$ . The channel condition or response is considered constant during the information signal transmission period. It changes for the next transmission period, while the channel conditions  $h_{SR}$ ,  $h_{RD}$  are recognizable, allowing the best relay selection in the selection strategy. Additive noise on all channels was modeled with a complex Gaussian random variable with a mean value of zero, and a variance value of  $\sigma_n^2 = N_0$ . Simply put, the power emitted

from the source to each relay is considered equal and denoted by  $P_S$ . The relay selection strategy selects the best channel conditions on the source-relay and destination-relay channels to determine the best relay, as shown in Fig. 2.

There are three periods in the cooperative transmission process. The first relay selection period is conducted based on channel conditions, namely source-relay channels and relay-destination channels. The first period is considered expeditious or has a short duration, hence, it does not interfere with the overall process of transmitting and receiving information signals. In the second period, the source sends an information signal to each relay and destination; then, the selected relay will receive the information signal from the source. In the third period, the selected relay will amplify the received signal and forward it to the destination using the AF protocol.

Mathematically, the signal received by a relay can be written as (1).

$$y_{SR} = \sqrt{P_S} h_{SR} x_S + n_{SR} \quad (1)$$

with  $P_S$  and  $x_S$  are the transmit power of the source and the information signal transmitted by the source. In contrast,  $h_{SR} \sim CN(0, \sigma_{SR}^2)$  and  $n_{SR} \sim CN(0, N_0)$  are the channel response and additive white gaussian noise (AWGN) in the relay-source channel, respectively. In the relay, the received signal will be amplified with a fixed gain value,  $G$ , and the output signal from the relay can be written as (2).

$$x_R = G y_{SR} \quad (2)$$

with

$$G = \sqrt{\frac{P_R}{P_S |h_{SR}|^2 + N_0}} \quad (3)$$

and  $P_R$  represents the transmit power in the relay.

For systems with multiple relays ( $L$ ), the total output signal from  $L$  relays received at the destination can be written as follows.

$$y_{RD} = \sum_{l=1}^L y_{R_lD}$$

with

$$y_{R_lD} = h_{R_lD}x_{R_l} + n_{R_lD} \quad (4)$$

with  $y_{R_lD}$  represents the signal transmitted from the  $l$ th relay to the destination.

By inputting (1) and (2) into (4), the following equation is obtained.

$$\begin{aligned} y_{SR_lD} &= h_{R_lD}G_l y_{SR_l} + n_{R_lD} \\ &= h_{R_lD} \left( \frac{\sqrt{P_R}}{\sqrt{|h_{SR_l}|^2 P_S + N_0}} \right) y_{SR_l} + n_{R_lD} \\ &= h_{R_lD} \left( \frac{\sqrt{P_R}}{\sqrt{|h_{SR_l}|^2 P_S + N_0}} \right) \{ \sqrt{P_S} h_{SR_l} x_s \} + n_{R_lD}^* \end{aligned} \quad (5)$$

with

$$n_{R_lD}^* = \left( \frac{\sqrt{P_R}}{\sqrt{|h_{SR_l}|^2 P_S + N_0}} \right) h_{R_lD} n_{SR_l} + n_{R_lD} \quad (6)$$

is regarded as an AWGN with a variance value of  $\frac{P_R |h_{R_lD}|^2 \sigma_{SR_l}^2}{P_S |h_{SR_l}|^2 \sigma_{R_lD}^2} + \sigma_{R_lD}^2$ , or it can be written as follows (7).

$$y_{SR_lD} = h_{SR_lD} x_s + n_{SR_lD} \quad (7)$$

with  $h_{SR_lD} = \sqrt{P_S} \left( \frac{\sqrt{P_R}}{\sqrt{|h_{SR_l}|^2 P_S + N_0}} \right) h_{SR_l} h_{R_lD}$  and  $n_{SR_lD} = n_{R_lD}^*$ . The total signal received by the destination is written as in (8).

$$y_D = y_{SD} + y_{SRD} = y_{SD} + \sum_{l=1}^L y_{SR_lD}. \quad (8)$$

If the relay selection strategy is applied and the  $l$ th relay is selected as the best relay, then, the signal received by the destination is shown on (5). The instantaneous signal-to-noise ratio (SNR) value of the signal received from the  $l$ th relay at the destination can be written as (9).

$$Y_{SR_lD} = \frac{P_S G_l |h_{SR_l} h_{R_lD}|^2}{\sigma_n^2 (G_l |h_{R_lD}|^2 + 1)}. \quad (9)$$

### B. Nonlinear Power Amplifier Model

The Rapp model is one of the models of nonlinear power amplifiers without memory that is widely applied to solid state power amplifiers (SSPA). To identify the nonlinear characteristics of the power amplifier, transfer functions AM-AM  $g[y(t)]$  and AM-PM  $\phi[y(t)]$  are used. Functions for the Rapp model can be defined in (10) and (11) [16].

$$g[y_{PA}(t)] = x(t) \frac{A}{\left[ 1 + \left( \frac{Ax(t)}{X_0} \right)^{2p} \right]^{\frac{1}{2p}}} \quad (10)$$

$$\begin{aligned} g[y_{PA}(t)] &= x(t)d(t) \\ d(t) &= \frac{A}{\left[ 1 + \left( \frac{Ax(t)}{X_0} \right)^{2p} \right]^{\frac{1}{2p}}} \end{aligned} \quad (11)$$

$$\phi[y_{PA}(t)] = 0$$

with  $g[y_{PA}(t)]$  represents the magnitude of the output signal,  $\phi[y_{PA}(t)]$  is the phase of the output signal, and  $d(t)$  is the distortion factor of the power amplifier. A nonlinear power amplifier will cause nonlinear distortion in the output signal and widen the signal spectrum or out-of-band radiation. Out-of-band radiations can interfere with the range of adjacent signals; for this reason, they need to be reduced or eliminated. The strategy used to eliminate the nonlinear effect is by applying a predistortion technique before the power amplifier. Predistorter is an inverse complex function model or the inverse to the nonlinear characteristics of a power amplifier. Predistorter will compensate for the characteristics or nonlinear nature of the power amplifier so that the power amplifier will linearly amplify the signal and generate an undistorted output signal. Predistorter for the SSPA Rapp model is the inverse of Rapp characteristics, written as (12) [17].

$$d^*(t) = \frac{A}{\left[ 1 - \left( \frac{Ax(t)}{X_0} \right)^{2p} \right]^{\frac{1}{2p}}}. \quad (12)$$

The output signal of the power amplifier after the distortion technique is applied can be stated as (13).

$$g[y_{PD}(t)] = x(t) \cdot d^*(t) \cdot d(t). \quad (13)$$

In addition to the memoryless model, the power amplifier can also be modeled as a high-power amplifier (HPA) with memory. One example of an HPA model with memory is the Wiener model, and for this model, the Hammerstein model is used to inverse the nonlinear characteristics of the Wiener model [18], [19]. The block diagram of the cascade connection of the Hammerstein and Wiener model is shown in Fig. 3 [20].

In polynomial form, the predistorter can be formulated as follows.

$$u(n) = \sum_{m=0}^M \lambda_m \left( \sum_{p=1}^P \alpha_p x^p(n-m) \right) \quad (14)$$

with  $M$  represents the memory length of the linear inverse filter and  $P$  is the power of nonlinearity, and

$$v(n) = \sum_{k=0}^K \beta_k \left( \sum_{m=0}^M \lambda_m \left( \sum_{p=1}^P \alpha_p x^p(n-m-k) \right) \right) \quad (15)$$

with  $\beta$  is the LTI filter coefficients. The output signal from the power amplifier block is shown as (16).

$$y(n) = f(v(n)) = \sum_{q=0}^Q \gamma_{2q-1} (v(n))^{2q-1}. \quad (16)$$

### C. Convolutional Coding

Convolution codes are known for their practicality. In the convolutional code, three parameters are used, namely  $n$ ,  $m$ ,

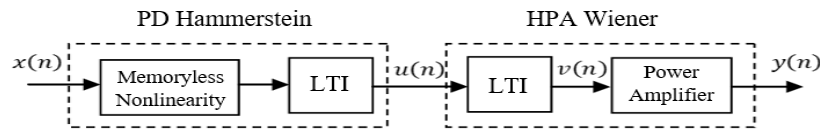

Fig. 3 The cascade block of Hammerstein-Wiener.

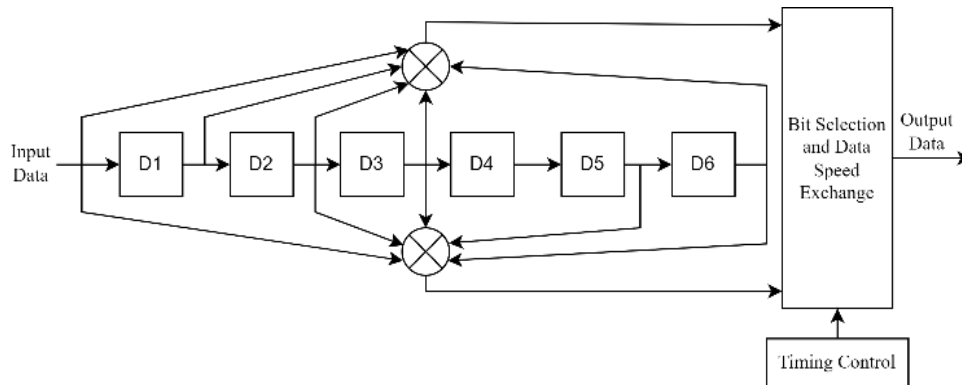

Fig. 4 Block diagram of convolution encoder.

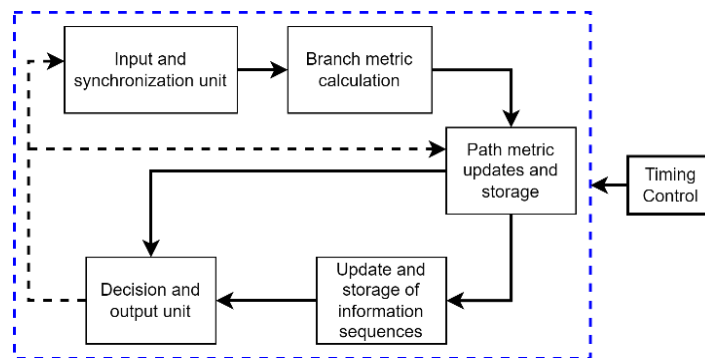

Fig. 5 Block diagram of Viterbi decoder.

and  $k$ , which are the number of output bits, the number of memory registers, and the number of input bits [21]. The code rate is the ratio between the number of input bits and the number of output bits,  $k/n$ . The block diagram of the convolution encoder is shown in Fig. 4. On the other hand, a Viterbi model decoder is used at the receiving end to process signals generated from convolutional coding, as shown in Fig. 5.

### III. SYSTEM OFFERED FOR RESEARCH

The block diagram of the cooperative communication system with the best single relay using the AF protocol and the channel coding technique; the distortion technique in the source and relay is shown in Fig. 6. The input bit sequence  $x(t)$  is encoded using convolutional encoding at a rate of  $1/2$  and produces a bit sequence of twice the length,  $x_c(t)$ . Then, the bit sequence is mapped using the QPSK modulation scheme to create a complex symbol sequence,  $x_{mod}(t)$ . Subsequently, the series of symbols are transformed into OFDM symbols through the SLM reduction technique with the smallest PAPR value,  $x_{OFDM}(t)$ . The symbols are passed through a predistorter and a nonlinear HPA to produce an information signal transmitted by the source,  $x_s(t)$ , received by a selected relay and a receiver at the destination.

The Rapp Model was chosen as a memoryless nonlinear power amplifier (PA) model in the relay. A predistorter is placed before the power amplifier after the amplification block to compensate for the nonlinear characteristics of the power amplifier. The nonlinear memoryless bandpass system used Bussgang's theorem with the input signal in a complex Gaussian such as an OFDM signal. The output signal of the selected relay (e.g. the  $l$ th relay) can be expressed as (17).

$$\begin{aligned} z_{R_l} &= K_{R_l} x_{R_l} + d_{R_l} \\ z_{R_l} &= K_{R_l} G_l y_{SR_l} + d_{R_l} \end{aligned} \quad (17)$$

with  $K_{R_l} = E[z_{R_l} x_{R_l}^* / P_R]$  is the amplification factor, while  $d_{R_l}$  is a time-domain noise nonlinear distortion with a mean of zero, uncorrelated with the input signal  $x_{R_l}$  and  $K_{R_l}$ . Therefore, the signal emitted from the  $l$ th selected relay to the destination can be written as follows.

$$\begin{aligned} y_{SR_l D} &= h_{R_l D} z_{R_l} + n_{R_l D} \\ y_{SR_l D} &= h_{R_l D} (K_{R_l} G_l y_{SR_l} + d_{R_l}) + n_{R_l D}, \text{ dan} \\ y_{SR_l} &= \sqrt{P_S} h_{SR_l} x_s + n_{SR_l} \\ y_{SR_l D} &= h_{R_l D} \{ K_{R_l} G_l (\sqrt{P_S} h_{SR_l} x_s + n_{SR_l}) + d_{R_l} \} + n_{R_l D} \end{aligned}$$

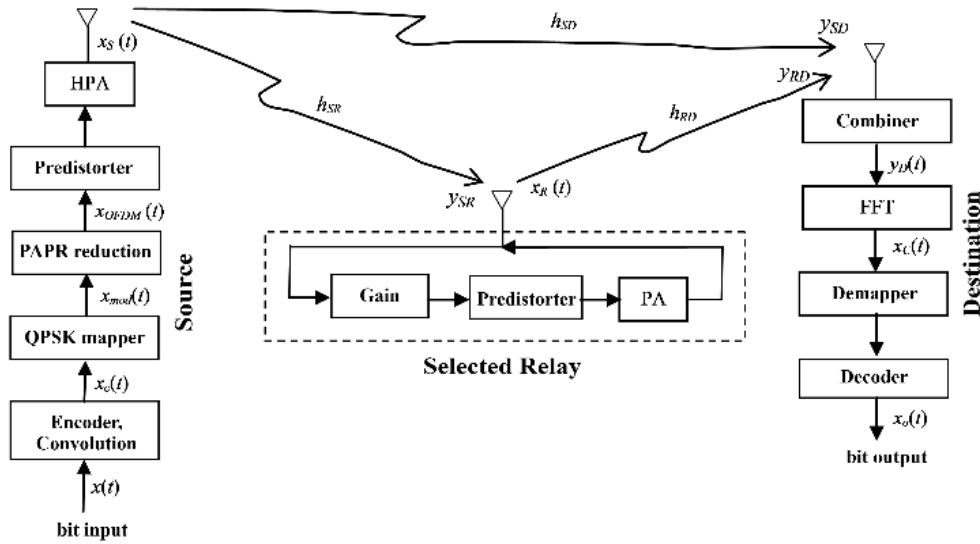

Fig. 6 The proposed system.

$$y_{SR_lD} = K_{R_l} G_l h_{SR_l} h_{R_lD} \sqrt{P_S} x_S + K_{R_l} G_l h_{R_lD} n_{SR_l} + h_{R_lD} d_{R_l} + n_{R_lD}$$

$$y_{SR_lD} = h_{SR_lD} \sqrt{P_S} x_S + n_{SR_lD} \quad (18)$$

with  $x_S$  represent the information signal from the source, or the output from the HPA nonlinear with memory, so that  $h_{SR_lD} = K_{R_l} G_l h_{SR_l} h_{R_lD}$  and  $n_{SR_lD} = K_{R_l} G_l h_{R_lD} n_{SR_l} + h_{R_lD} d_{R_l} + n_{R_lD}$ . The instantaneous SNR of the signal received at the destination from the source through the  $l$ th selected relay can be written as (19).

$$\gamma_{SR_lD} = \frac{P_S |G_l K_{R_l} h_{SR_l} h_{R_lD}|^2}{N_0 (|G_l K_{R_l} h_{R_lD}|^2 + 1)} \quad (19)$$

or can be written as (20),

$$\gamma_{SR_lD} = \frac{\gamma_{SR_l} \gamma_{R_lD(PA)}}{\gamma_{SR_l} + \gamma_{R_lD(PA)} + 1} \quad (20)$$

with instantaneous SNR, the signals received at the  $l$ th selected relay from the source and the signal received at the destination from the  $l$ th selected relay with the power amplifier are formulated in (21).

$$\gamma_{SR_l} = \frac{P_S |h_{SR_l}|^2}{N_0}, \quad \gamma_{R_lD(PA)} = \frac{G_l^2 K_{R_l}^2 P_R |h_{R_lD}|^2}{N_0} \quad (21)$$

The AWGN variance on all channels or lines is considered to be  $\sigma_{SD}^2 = \sigma_{RD}^2 = \sigma_{SR}^2 = N_0$ .

In a wireless environment without interference, the conventional relay selection strategy is sufficient to be applied. This type of strategy requires instantaneous strong signal or SNR on the channel, or the path between the source to the selected relay,  $S - R_l$  and the specified relay to the destination,  $R_l - D$ ,  $h_{SR_l}$ ,  $h_{R_lD}$ . The conventional type relay selection strategy can be formulated as (22) [22].

$$L^{th} = \max_{l \in L} \min \{SNR_{SR_l}, SNR_{R_lD}\} = \max_{l \in L} \min \{\gamma_{SR_l}, \gamma_{R_lD}\}. \quad (22)$$

After combining the signals from the source and the selected relay, the total upper bound SNR at the destination can be written as (23) [22].

$$\gamma_D = \gamma_{SD} + \max_{l \in L} \min \{\gamma_{SR_l}, \gamma_{R_lD}\}$$

$$= \gamma_{SD} + \max_{l \in L} \min \left\{ \frac{\gamma_{SR_l} \gamma_{R_lD}}{\gamma_{SR_l} + \gamma_{R_lD} + 1} \right\} \quad (23)$$

with  $L^{th}$  denotes the notation for selecting the maximum value of  $\gamma_l$  and  $\gamma_l = \min(\gamma_{SR_l}, \gamma_{R_lD})$ .

PDF from  $\gamma_l$  can be stated as  $f_{\gamma_l}(\gamma) = 1/\bar{\gamma}_l \exp(-\gamma/\bar{\gamma}_l)$ , where the notation for the mean SNR of  $\gamma_{SR_l}$  is  $\bar{\gamma}_{SR_l}$  and SNR mean for  $\gamma_{R_lD}$  is  $\bar{\gamma}_{R_lD}$ . Next,  $\bar{\gamma}_{SR_l} = \mathbf{E}(|h_{SR_l}|^2) E_S/N_0$  and  $\bar{\gamma}_{R_lD} = \mathbf{E}(|h_{R_lD}|^2) E_S/N_0$ , so that the average SNR value of  $\gamma_l$  can be written as (24).

$$\bar{\gamma}_l = \bar{\gamma}_{SR_l} \bar{\gamma}_{R_lD} / \bar{\gamma}_{SR_l} + \bar{\gamma}_{R_lD}. \quad (24)$$

Applying a nonlinear power amplifier in the relay, (19) can be written as (25).

$$\gamma_D = \gamma_{SD} + \max_{l \in L} \min \left\{ \frac{\gamma_{SR_l} \gamma_{R_lD(PA)}}{\gamma_{SR_l} + \gamma_{R_lD(PA)} + 1} \right\}. \quad (25)$$

The average BER of the relay selection strategy can be calculated using the PDF  $f_{\gamma_D}(\gamma)$  of  $\gamma_D$  and written as (26).

$$BER_b(\gamma) = \int_0^\infty Q(\sqrt{\gamma}) f_{\gamma_D}(\gamma) d\gamma \quad (26)$$

with  $Q$  is an error function.

#### IV. SIMULATION RESULT

To do the simulation, the following parameters are used.

- Cooperative protocol: amplify and forward (AF).
- The number of OFDM system subcarriers: 256.
- Modulation type: QPSK.
- Channel model: Rayleigh fading.
- The number of OFDM symbols: 1,000 symbols.

- Relay selection strategy: conventional.
- The number of relays: two, four, and six relays.

The best relay selection depends not on the number of relays but on the relay selection algorithm used. This paper used a conventional type relay selection algorithm, namely, the best relay was selected by considering the SNR value from the source to the relay and the relay to the destination, so that two, four, and six relays were used only to compare the performance of the BER obtained.

The convolutional coding performance of the system that has been studied toward the application of the distortion technique at the source is shown in Fig. A1. Performance was evaluated for two and four relays and implementation of relay selection strategy. Fig. A1 delivers the performance of the convolutional coding technique with the application of the distortion technique at the source. Observations were made on the system using the SLM reduction technique and predistortion (PD) on the relay. Based on Fig. A1, in the two-relays scheme, BER  $10^{-3}$  in the system without predistortion and convolution coding is achieved at an SNR value of 30 dB, while with convolutional coding BER  $10^{-3}$  is achieved at an SNR value of 22 dB. This result indicates that convolutional coding can improve system performance by 8 dB or 26.67%. In the same BER observation, the system with predistortion and without convolutional coding required an SNR of 19.5 dB. In contrast, the system only required an SNR of 16 dB by adding convolutional coding. Therefore, convolutional coding could improve the system performance by 3.5 dB or 17.95%. In the four relay scheme, BER  $10^{-4}$  in the system with and without predistortion without using convolutional coding was achieved at SNR, 20.5 dB, and 30 dB, respectively. Whereas by applying convolutional coding, BER  $10^{-4}$  was achieved at SNR value of 16.5 dB and 23 dB. Thus, it was revealed that convolutional coding could improve system performance by 7 dB or 23.33% for systems without predistortion, and by 4 dB or 19.51% for systems with predistortion.

The convolutional coding performance on the system under study toward the distortion technique's application in the relay is shown in Fig. A2. Performance is evaluated for the number of two and four relays with the implementation of the relay selection strategy.

Fig. A2 presents the predistortion technique performance in the relay with and without the application of convolutional coding at the source. Based on Fig. A2, in a two-relays system, to obtain the value of BER  $10^{-3}$  on a system without predistortion and without convolution coding, an SNR of 21.5 dB is required. In comparison, a system with convolutional coding only requires an SNR of 18 dB. Therefore, it shows that convolutional coding can improve the system performance by 3.5 dB or 16.28%. However, by applying predistortion, better system performance could be obtained as the system only required an SNR of 19.5 dB for systems without convolutional coding and 16 dB for systems with convolutional coding. Hence, the convolutional and predistortion coding system could increase the system performance by 3.5 dB or 17.95%. BER  $10^{-4}$  values in systems with and without predistortion without convolutional coding were achieved at SNR values of 20.5 dB

and 30 dB in a four-relays system. By applying convolutional coding, the BER was reached at 16.5 dB and 19.5 dB SNR values. Thus, it indicated that convolutional coding could improve system performance by 10.5 dB or 35% for systems without predistortion and by 4 dB or 19.51% for systems with predistortion.

The predistortion technique performance in the source and relay system that has been studied with and without the application of convolutional coding is shown in Fig. A3 and Fig. A4. The system's performance was evaluated for the two and four relays by applying the PAPR SLM reduction technique and relay selection strategy.

Fig. A3 shows that the system without convolutional coding performs best when the predistortion technique is applied in the source and relay for a four-relay system. The system only required an SNR of 21 dB at BER  $10^{-4}$ , while other signals could not reach BER  $10^{-4}$ . Meanwhile, Fig. A4 shows that to achieve BER  $10^{-4}$  with the application of convolutional coding, an SNR of 16.5 dB is required in a four-relay system. It also suggests that convolutional coding can improve system performance by obtaining a lower BER value or a lower SNR value at the same BER value.

In addition, based on Fig. A3 and Fig. A4, the best system performance is obtained when the two-point distortion technique is applied, namely the source and relay. However, it is also revealed that the distortion technique application at the source provides a more significant increase in the system performance than the distortion technique application in the relay. It is proved in Fig. A3 (system without convolutional coding for four relays), with the observation in BER  $10^{-3}$ , the predistortion technique application on both sides can improve the performance of the system compared to the application at the source only, in the relay only, and without the predistortion technique application on both sides. The increases were 2.5 dB or 11.76%, 6.5 dB or 25.74%, and 9.25 dB or 33%. Furthermore, Fig. A4 (system with convolution coding for four relays) suggests that applying the distortion technique on both sides can improve the system performance. System performance increased by 3.25 dB or 16.46% compared to the source-only application, 6.5 dB or 28.26% compared to relay-only application, and 8.5 dB or 34% compared to no application on both sides. Observations were made at BER  $10^{-4}$ .

The performance of the convolutional coding on the system studied for multi-relay with the application of the relay selection strategy is shown in Fig. A5. It shows that the convolutional coding technique can improve system performance. Observations were made on the system by applying the SLM reduction technique, the distortion technique at the source, and at the relay. The best system was obtained by applying convolutional coding to six relays as it only required an SNR of 17.1 dB at BER  $10^{-4}$ . On the other hand, in the test without the application of convolution coding, an SNR of 20.5 dB was required at the same BER value. Thus, it showed that the application of convolutional coding could increase system performance by 3.4 dB or 16.59%. In addition, it is also known that by adding convolution coding, the obtained signal will be more stable than without applying it. This finding occurs

because the transmitted signal will be more invulnerable to the effects of Rayleigh fading by using convolutional coding.

## V. CONCLUSION

From the simulation results of the application of the combined SLM technique and Hammerstein's predistortion on the source side and the addition of predistortion on the relay side in the AF system with a relay selection strategy, it can be concluded that the convolutional coding technique could improve system performance up to 16.59%, both with and without the application of the predistortion technique. However, the application of the distortion technique on both sides (source and relay) was able to produce the best performance; the system performance could increase by 16.46% compared to the application at the source only, by 28.26% compared to the application in the relay only, and reached 34% compared to the system without the application of the distortion technique. In addition, the implementation of the conventional type relay selection strategy indicates that the scheme with the most relays, namely six relays, can produce the best performance due to the increasing number of available path choices.

## CONFLICTS OF INTEREST

The authors declare no conflict of interest.

## AUTHOR CONTRIBUTIONS

Conceptualization, Annisa Anggun Puspitasari and Mareta Dwi Nor Habibah; methodology, Annisa Anggun Puspitasari; software, Annisa Anggun Puspitasari and Mareta Dwi Nor Habibah; validation, Ida Anisah and Yoedy Moegiharto; formal analysis, Annisa Anggun Puspitasari; data curation, Annisa Anggun Puspitasari; writing—original draft preparation, Annisa Anggun Puspitasari and Mareta Dwi Nor Habibah; writing—review and editing, Ida Anisah and Yoedy Moegiharto; visualization, Ziyadatus Shofiyah; supervision, Ida Anisah and Yoedy Moegiharto; project administration, Ziyadatus Shofiyah.

## ACKNOWLEDGEMENT

Authors would like to acknowledge the Directorate General of Vocational Education, Ministry of Education and Culture of Republic of Indonesia for funding this research through Student Creativity Program of Exact Research in 2021.

## REFERENCES

- [1] J. Jeong, "New Digital Predistortion Technique of RF Power Amplifiers for Wideband OFDM Signals," *IEICE Electron. Express*, Vol. 9, No. 5, pp. 326–332, 2012.
- [2] Z.-Y. Mao, X. Wu, F.-P. Lu, M. Fan, Z.-Y. Mao, and C.-H. Liu, "A New RF Power Amplifier Linearization Method," *Adv. Comput. Sci. Res.*, Vol. 44, pp. 11–14, 2017.
- [3] E.A. Hussein, "Enhancing the BER and ACLR for the HPA Using Predistortion Technique," *Int. J. Electr. Comput. Eng.*, Vol. 9, No. 4, pp. 2725–2731, 2019.
- [4] M.O. Hasna and M.S. Alouini, "End-to-End Performance of Transmission Systems with Relays Over Rayleigh-Fading Channels," *IEEE Trans. Wireless Commun.*, Vol. 2, No. 6, pp. 1126–1131, 2003.
- [5] P.A. Anghel and M. Kaveh, "Exact Symbol Error Probability of a Cooperative Network in a Rayleigh-Fading Environment," *IEEE Trans. Wireless Commun.*, Vol. 3, No. 5, pp. 1416–1421, 2004.
- [6] M.I. Khalil, S.M. Berber, and K.W. Sowerby, "Bit Error Rate Performance Analysis in Amplify-and-Forward Relay Networks," *Wireless Netw.*, Vol. 23, No. 3, pp. 947–957, 2017.
- [7] H. Jing, L. Juhu, and Z. Haiyan, "Performance Analyses of OFDM AF Relaying System in the Presence of Phase Noise with APS and IPS," *J. China Univ. Posts Telecommun.*, Vol. 23, No. 5, pp. 1–9, 2016.
- [8] V. del Razo, T. Riihonen, F. Gregorio, S. Werner, and R. Wichman, "Nonlinear Amplifier Distortion in Cooperative Amplify-and-Forward OFDM Systems," *2009 IEEE Wireless Commun. Netw. Conf. (WCNC)*, 2009, pp. 1–5.
- [9] P.K. Singya, N. Kumar, and V. Bhatia, "Mitigating NLD for Wireless Networks," *IEEE Microw. Mag.*, Vol. 18, No. 5, pp. 73–90, 2017.
- [10] A.I. Akin and H. Ilhan, "Relay Selection for AF Based Cooperative Networks," *Int. J. Tech. Res. Appl.*, No. 19, pp. 26–29, 2015.
- [11] A. Adinoyi, Y. Fan, H. Yanikomeroglu, H.V. Poor, and F. Al-Shaalani, "Performance of Selection Relaying and Cooperative Diversity," *IEEE Trans. Wireless Commun.*, Vol. 8, No. 12, pp. 5790–5795, 2009.
- [12] E. Balti and M. Guizani, "Impact of Nonlinear High-Power Amplifiers on Cooperative Relaying Systems," *IEEE Trans. Commun.*, Vol. 65, No. 10, pp. 4163–4175, 2017.
- [13] S.R.C. Magalhães, C.A.R. Fetnandes, and L.C.S. Teles, "Relay Selection Methods for Cooperative OFDM Systems with Nonlinear Power Amplifiers," *Proc. IEEE Symp. Comput. Commun.*, 2018, pp. 990–995.
- [14] M. Majidi, A. Mohammadi, A. Abdipour, and M. Valkama, "Characterization and Performance Improvement of Cooperative Wireless Networks with Nonlinear Power Amplifier at Relay," *IEEE Trans. Veh. Technol.*, Vol. 69, No. 3, pp. 3244–3255, 2020.
- [15] R. Nuriadnyana, A. Fahmi, and B. Syihabuddin, "Perbandingan PAPR Metode CSLM dan SLM pada Pengirim OFDM," *J. Nas. Tek. Elektro Teknol. Inf.*, Vol. 8, No. 1, pp. 53–58, 2019.
- [16] C. Rapp, "Effects of HPA-Nonlinearity on a 4-DPSK/OFDM Signal for a Digital Sound Broadcasting System," *Proc. 2nd Eur. Conf. Satell. Commun.*, 1991, pp. 179–184.
- [17] M. Shabany and P.G. Gulak, "Efficient Compensation of the Nonlinearity of Solid-State Power Amplifiers Using Adaptive Sequential Monte Carlo Methods," *IEEE Trans. Circuits Syst. I Regul. Pap.*, Vol. 55, No. 10, pp. 3270–3283, 2008.
- [18] P.L. Gilabert, G. Montoro, and E. Bertran, "On the Wiener and Hammerstein Models for Power Amplifier Predistortion," *Asia-Pacific Microw. Conf. Proc. (APMC)*, 2005, pp. 1–4.
- [19] F. Taringou, O. Hammi, B. Srinivasan, R. Malhame, and F.M. Ghannouchi, "Behaviour Modelling of Wideband RF Transmitters Using Hammerstein-Wiener Models," *IET Circuits, Devices Syst.*, Vol. 4, No. 4, pp. 282–290, 2010.
- [20] H. Karkhaneh, A. Ghorbani, and H. Amindavar, "Quantifying and Cancellation Memory Effects in High Power Amplifier for OFDM Systems," *Analog Integr. Circuits Signal Process.*, Vol. 72, No. 2, pp. 303–312, 2012.
- [21] C. Yang, M. Zhan, Y. Deng, M. Wang, X.H. Luo, and J. Zeng, "Error-correcting Performance Comparison for Polar Codes, LDPC Codes and Convolutional Codes in High-performance Wireless," *2019 6th Int. Conf. Inf., Cybern. Comput. Soc. Syst. (ICCSS 2019)*, 2019, pp. 258–262.
- [22] N. Kumar and V. Bhatia, "Performance Analysis of Amplify-and-Forward Cooperative Networks with Best-Relay Selection Over Weibull Fading Channels," *Wireless Pers. Commun.*, Vol. 85, No. 3, pp. 641–653, 2015.



Appendix

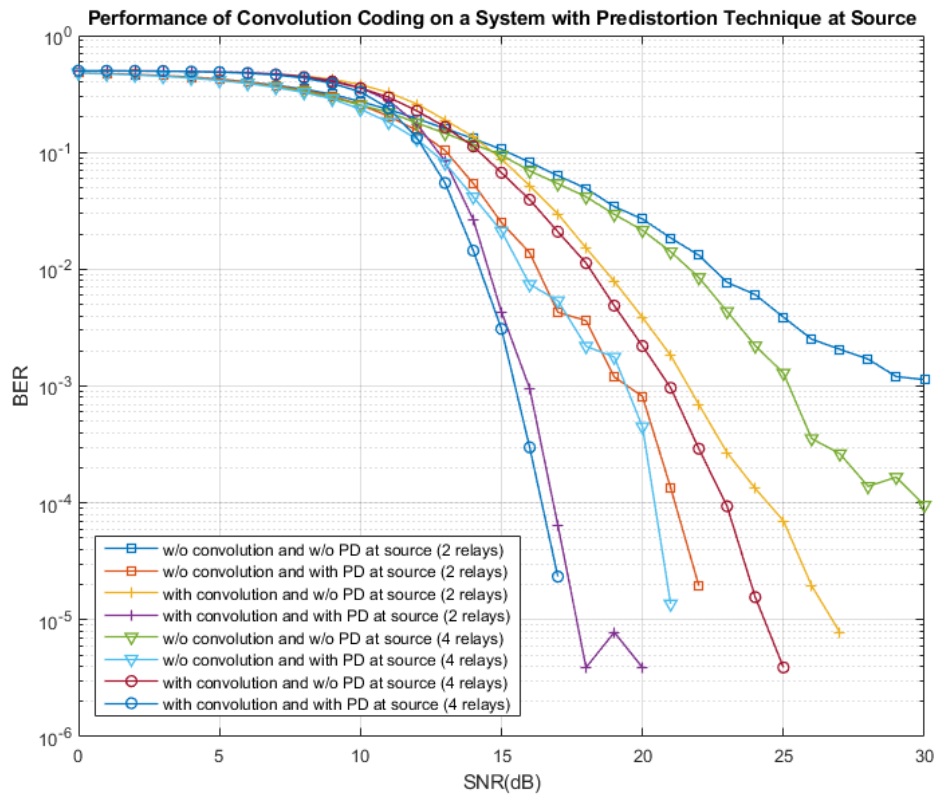

Fig. A1 Performance of convolution coding on a system with the application of the predistortion technique at source.

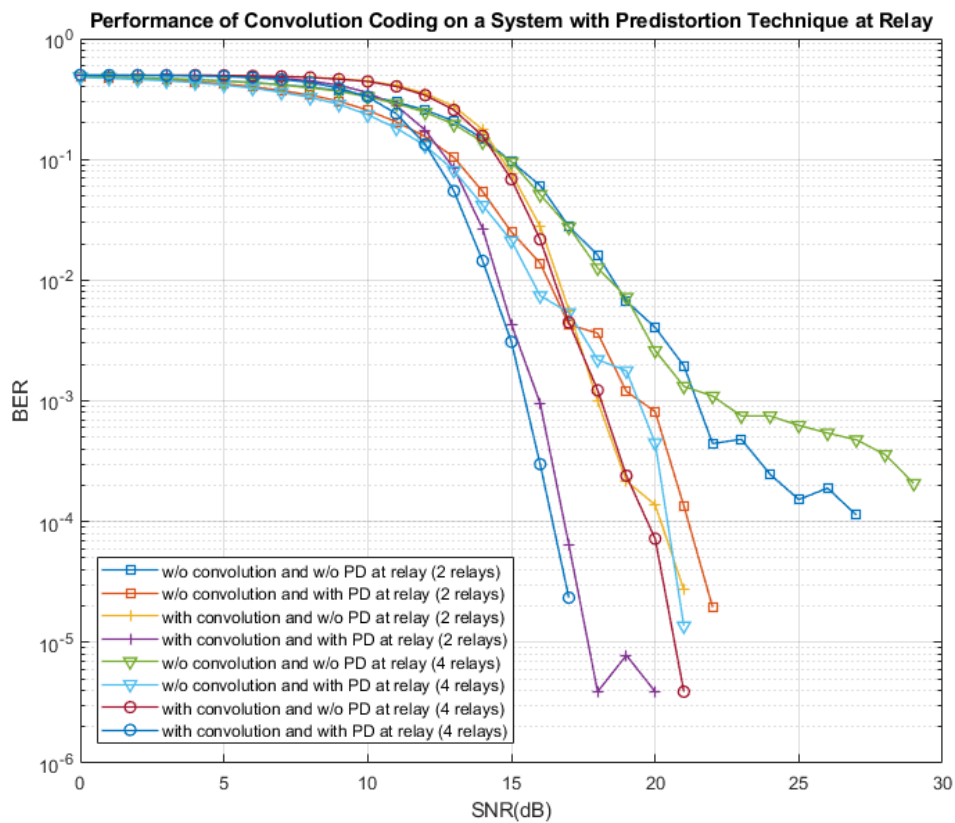

Fig. A2 Performance of convolution coding on a system with the application of the predistortion technique at relay.



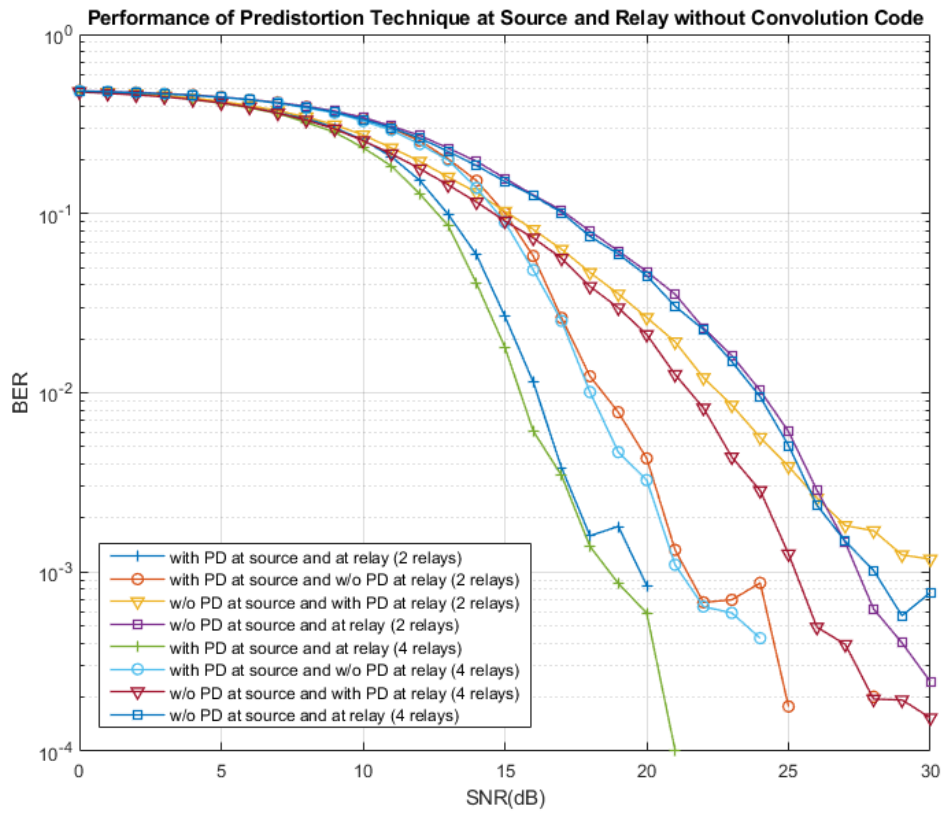

Fig. A3 Performance of predistortion techniques at source and relay on a system without convolution coding application.

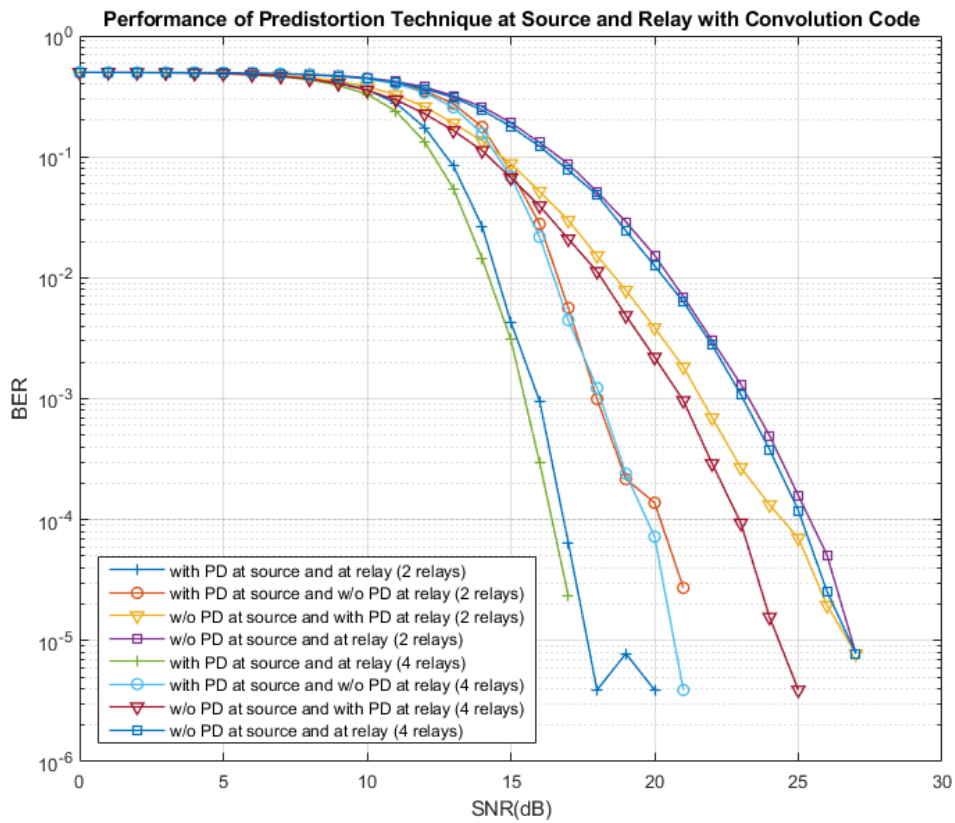

Fig. A4 Performance of predistortion techniques at source and relay on a system with convolution coding application.

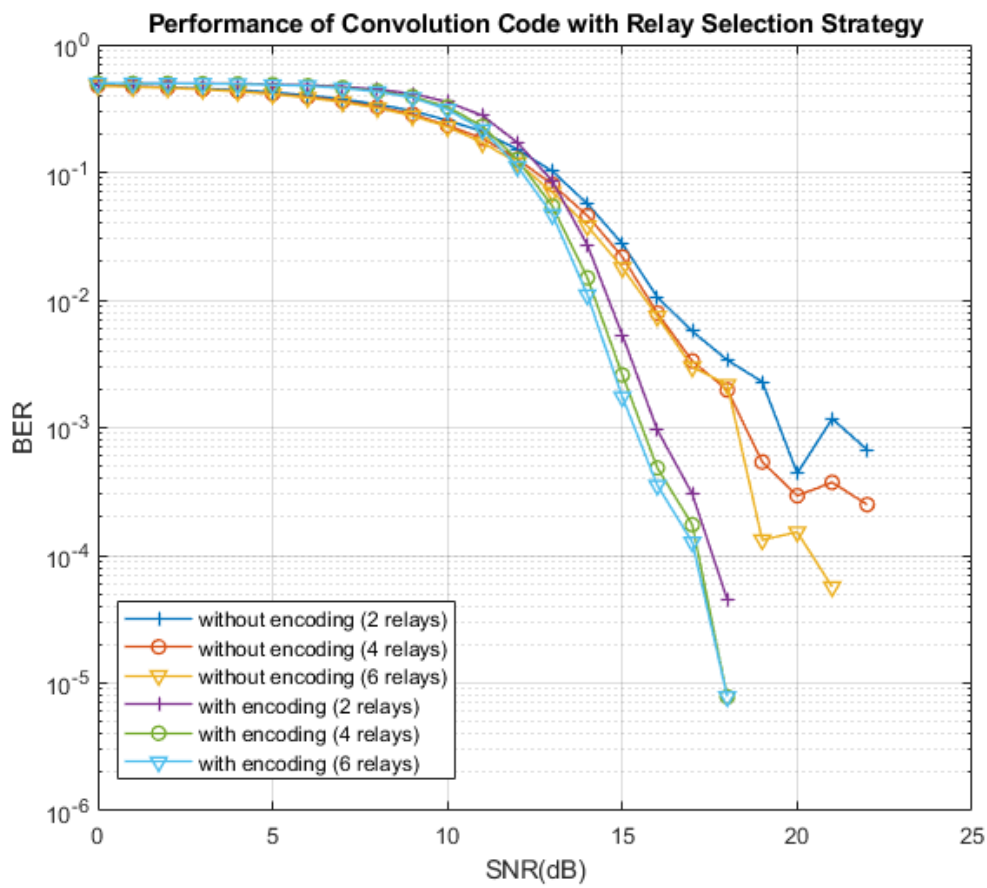

Fig. A5 Performance of convolution coding on the system.