

A New Flow Injection System with Merging-Zone Technique for the Determination of Copper(II) by Neocuproine Reagent in Aqueous Solution

Ahmed Saleh Farhood^{1*} and Dakhil Nassir Taha²

¹Department of Chemistry, College of Science, University of Babylon, Hilla 51002, Iraq

²Department of Chemistry, College of Sciences for Women, University of Babylon, Hilla 51002, Iraq

* **Corresponding author:**

email: sci.ahmed.saleh@uobabylon.edu.iq

Received: November 29, 2021

Accepted: February 1, 2022

DOI: 10.22146/ijc.70799

Abstract: A fast, simple, and high throughput sample merging-zone flow injection design was developed to determine copper(II) in an aqueous solution. The procedure is based on the reduction of copper(II) to copper(I) by uric acid followed by a direct reaction with Neocuproine reagent (NC). The orange-yellow complex that forms absorbs light at 454 nm. All conditions of the new flow injection unit were investigated. The analytical curve of copper(II) was linear with an r^2 value of 0.9978, in the range of 0.4 to 40 mg/L with a detection limit of 0.1 mg/L and a quantification limit of 0.3 mg/L. The molar absorptivity was 1.661×10^5 L/mol cm, and the recovery range was between 104.9 and 97%. The homemade acrylic valve was low-cost with zero dead volume and high repeatability ($n = 7$) with an RSD of 2.31%. The dispersion coefficient values were 1.8, 1.62, and 1.31 for the concentrations of 5, 15, and 25 mg/L, respectively. The sample throughput was 69 h^{-1} .

Keywords: merging-zone; copper(II); Neocuproine; homemade valve; dead volume

■ INTRODUCTION

Copper is one of the major trace elements in many biological and industrial processes, organic fertilizers, electroplating, nanotechnology, and sewage sludge [1-3]. Cu(II) is directly reduced by uric acid (UA), ascorbic acid (AA), and or other reducing agents [4-5]. Copper(I) reacts with 2,9-Dimethyl-1,10-phenanthroline (NC) to produce a complex that absorbs light at 454 nm [6]. The merging-zone flow injection method has low consumption of chemicals during analysis [7]. Consequently, a homemade valve can be used to determine copper with NC reagent by merging-zone FIA technique.

The Cu(I)-NC complex has high stability constant [8]. The complexation ratio of Cu(I)-NC is 1:2 with an optimum pH of 7 [9]. Based on Cu-NC complex represents a new Redox mediator, and it is used as an electrode [10]. Cu(I) is determined in the form of Cu(I)-BCS (bathocuproine_disulfonicacid) complex when Cu is accumulated by electrolysis of a plating solution [11]. Based on the reduction of Cu(II)-NC by ascorbic acid, the

Cu(I) is formed and then reacts with NC reagent to produce an orange-yellow colored complex, then ascorbic acid was determined [12-13]. Cu in water is determined by using the interaction between Cu(I) with one derivative of Neocuproine immobilized on modified silica based on the adsorption-photometric method [14].

The flow injection analysis (FIA) method was used for the Neocuproine-copper complex on a modified surfactant electrode to determine hydrazine [15]. The FIA unit was used to determine Cu with a low sample throughput value at 15 h^{-1} ; the reaction time for one analysis was 4 min [16]. The reaction between Cu(II) and reducing sugars in the presence of NC reagent was used for determining sugars. This novel principle is based on flow injection analysis and is considered as a fast, simple, analytically versatile, and accurate method [17]. An FIA method based on the reaction of Cu(II) with NC reagent was designed to determine *N*-acetyl-L-cysteine, with a maximum sample throughput of 180 h^{-1} [18]. Stop FIA was applied in the determination of Cu(II) by 4-(2-pyridylazo)resorcinol reagent as a carrier

solution at 525 nm [19]. The hybrid flow system based on the reaction between *N*-acetyl-L-cysteine and Cu(II)-NC was applied to determine *N*-acetyl-L-cysteine. An orange-yellow complex of Cu(I)-NC was obtained at 458 nm with a throughput sample of 100 h⁻¹ [20]. Cu(II) was determined by flow injection analysis depending on the reaction of *N,N'*-*o*-phenylene-bis(3-methoxysalicylidene imine) with Cu(II) at a sample throughput more than 60 h⁻¹ [21]. The automatic FIA unit was used to determine the total antioxidant capacity in urine and serum samples based on the reduction of Cu(II)-NC to colored Cu(I)-NC [22].

This paper describes a new merging-zone technique for copper determination by flow injection. This method is a simple, high throughput, and high precision method for copper(II) determination in an aqueous solution with an inexpensive homemade valve. In this novel technique, Cu(II) is reduced directly by uric acid to Cu(I) that reacts with a specific Neocuproine reagent to form an orange-yellow complex that absorbs light at 454 nm.

■ EXPERIMENTAL SECTION

Materials

2,9-Dimethyl-1,10-phenanthroline (Neocuproine Reagent)(Merck), Uric acid (BDH), copper(II) chloride anhydrous (BDH), sodium hydroxide (Merck), hydrochloric acid (Chem-Lab), and absolute ethanol(Chem-Lab) were used. The chemicals and reagents used were of analytical grade. The water used was deionized and distilled.

Instrumentation

A 4-channel Peristaltic pump from Ismatec (Germany) with their tubing was used for thrusting the carrier solution. A manual flow injection valve, made of plastic, acrylic, and a three-way dispenser, was used for loading and injecting the sample, reagent, and reference carrier solution in the flow injection unit. UV-VIS spectra were acquired using a single-beam APEL, PD-303 (Japan) UV spectrophotometric for spectrometric measurements by flow injection analysis. The spectrophotometer was connected to the Kompensograph recorder C1032 Siemens (Germany) to obtain data as a peak height. The

flow cell (1 cm optical path) was obtained from Helmma (UK) with two vents for input and output with a volume capacity of 450 μL. The pH meter Philips Pw 9421 (Germany) was used to measure pH. The double-beam spectrophotometer Shimadzu UV-1700 (Japan) was used to determine the maximum wavelength.

Procedure

Solutions and reagents

A stock solution of copper(II) 250 mg/L was prepared in distilled water. The working solution of copper(II) was acquired by diluting the stock solution with a suitable volume of distilled water. A stock solution of uric acid 250 mg/L was prepared by dissolving 0.025 g of uric acid in 5 mL of 0.1 M sodium hydroxide solution [23]. Then the volume was completed to 100 mL by distilled water. The working solution of uric acid was acquired by diluting the stock solution with a suitable distilled water volume, and then pH was adjusted using 0.1 M hydrochloric acid or 0.1 M sodium hydroxide. A stock solution of NC reagent 1000 mg/L was prepared in 10% (v/v) of absolute ethanol [24]. Working solutions of NC reagent were prepared by dilution in distilled water.

Method principle

The copper(II) determination method that is used in this article is based on the redox properties of uric acid and copper(II). The reactions which occur are as follows: Copper(II) + Uric acid(reduced form) → Copper(I) + Uric acid(oxidized form) (1)

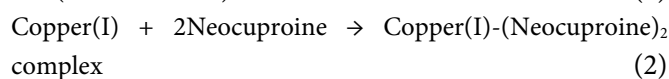

Uric acid is colorless in the oxidized form, but when the positively charged Cu(I)-Neocuproine complex forms, the color becomes orange-yellow and absorbs light at 455 nm. The combination ratio is Cu(I) 1:2 Neocuproine [25-26], as shown in Fig. 1.

Analysis module of merging-zone flow injection

The merging-zone of the flow injection unit with spectrophotometric detection to determine Cu(II) in an aqueous solution with a simple and fast flow injection system is shown in Fig. 2, where: C is the carrier solution (uric acid 150 mg/L), P is the peristaltic pump (flow rate

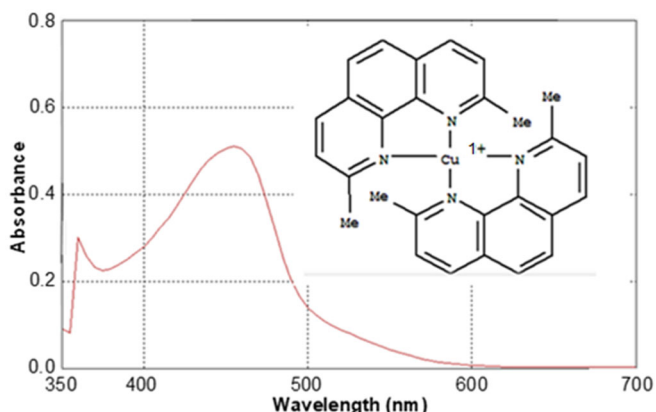

Fig 1. Absorption spectra of Cu(I)-NC complex. Wavelength 455 nm at Cu(II) 15 mg/L, NC reagent 600 mg/L, Uric acid concentration 150 mg/L, and pH 7

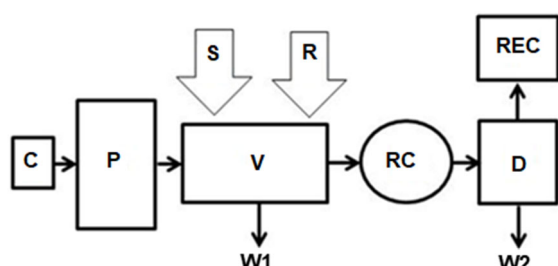

Fig 2. Schematic diagram of the flow-injection unit for determination copper(II), where: C- uric acid carrier, P- peristaltic pump, V- injector valve, S- sample loop, R- Neocuproine loop, W1- injection waste (sample and reagent), RC- tubular reaction coil 150 cm, D- UV-VIS spectrophotometer, REC- Kompensograph and W2- unit waste

of 6.5 mL/min), V is the injector valve with two loops (homemade), S is the sample solution loop (78.5 μL of copper(II)), R is the reagent solution loop (157 μL of 600 mg/L Neocuproine), W1 is the injection waste (sample and reagent), RC is the tubular reaction coil 150 cm, D is the UV-VIS spectrophotometer 454 nm, REC is the Kompensograph at 0.2 volts, and W2 is the unit waste.

Mechanical operation diagram of the homemade valve

The schematic diagram of the homemade working valve shows in Fig. 3. The first stage involved the suction of 150 mg/L of uric acid (adjusted at pH 7) as the carrier solution to all the parts of the unit by a peristaltic pump at a flow rate of 6.5 mL/min. Uric acid represents the reference solution (blank solution) and reducing agent.

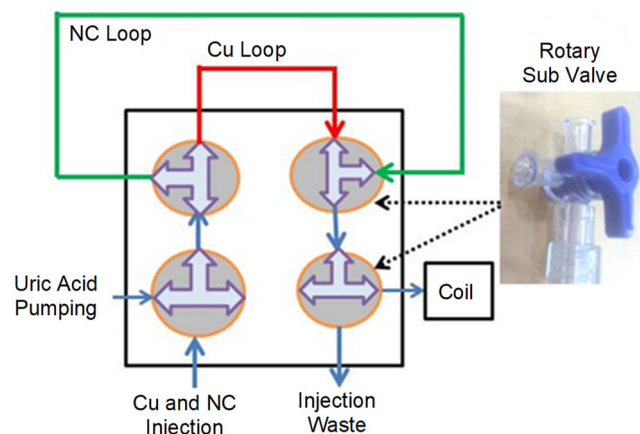

Fig 3. Schematic diagram of the homemade valve working

The second and third stage includes stopping the pump and injecting 157 μL of 600 mg/L NC reagent solution in the specific loop (represented by the green line in Fig. 3 and injecting 78.5 μL of the Cu(II) sample solution in the loop (represented by the red line in Fig. 3). Then uric acid carries the copper and NC from loops to the tubular reaction coil (150 cm). At first, uric acid reduces Cu(II) to Cu(I). Subsequently, the NC reagent reacts with Cu(I) to form an orange-yellow complex that absorbs light at 454 nm. The change in peak height of the Kompensograph was proportional to the Cu(II) sample concentration/reference carrier solution (uric acid).

RESULTS AND DISCUSSION

The Effect of Uric Acid Concentration

The effect of uric acid concentration on the height of the peak was studied in the range of 25–250 mg/L. The conditions of the study were: pH = 10 of uric acid 117.00 μL of 400 mg/L NC reagent, a flow rate of 3.8 mL/min, reaction coil length of 100 cm, and 47.1 μL of 15 mg/L Cu(II) solution. The preferred peak height of 2.7 cm was obtained at a uric acid concentration of 150 mg/L, as shown in Fig. 4.

The pH Effect of the Carrier Solution

The effect of pH was studied in the range of 3–10. The study was conducted using the selected concentration of uric acid (150 mg/L). The other conditions of the study include 117.00 μL of 400 mg/L NC reagent, a flow rate of 3.8 mL/min, reaction coil length of 100 cm, and

47.1 μL of 15 mg/L Cu(II) solution. As shown in Fig. 5, the optimal pH was seven at a peak height of 5 cm. The consequence obtained in this study corresponds to the results of Gaál et al. [9] and Ribeiro et al. [16].

The Effect of the Flow Rate of Uric Acid Solution

The effect of the flow rate of the carrier solution on the height of the peak was studied at 0.9, 2.3, 3.8, 5.2, 6.5, and 7.8 mL/min. Optimum parameters were used in the study, which includes: 150 mg/L uric acid concentration at pH 7, 117.00 μL of 400 mg/L NC reagent, reaction coil length of 100 cm, and 47.1 μL of 15 mg/L of Cu(II) solution. The best peak height was 3.6 cm at the carrier solution flow rate of 6.5 mL/min, as shown in Fig. 5. Although the response at low flow rates was greater than the higher flow rates, the shape of the peak was wide and double. For this reason, the flow rate of 6.5 mL/min was selected because the response was sharp and dependable. Authors found that low flow rates cause double, distorted, and wide peaks, while the fast flow rates decrease the response.

The Effect of the Cu(II) Sample Volume

The optimal conditions of the flow rate of the carrier solution, pH, and uric acid concentration were fixed at 6.5 mL/min, 7, and 150 mg/L, respectively. The effect of the Cu(II) sample volume on the shape and sensitivity of the peak height was studied at 47.1, 78.5, 117, 157, and 196.25 μL using 117.00 μL of 400 mg/L NC reagent, reaction coil length of 100 cm, and 15 mg/L of Cu(II) solution. It was observed that the highest response of 4 cm was obtained at 78.5 μL of Cu(II) sample solution, as shown in Fig. 6. In comparison, Dakhil and Zuhair found that the response decreased when using a very high sample volume because of the dilution process [27].

The Effect of the Neocuproine Reagent Volume

The effect of the NC reagent volume on the peak height was studied at values of 117, 157, 196.25, and 235.5 μL at optimal conditions as follows: flow rate of carrier solution of 6.5 mL/min, pH 7, the uric acid concentration of 150 mg/L, and 78.5 μL of 15 mg/L Cu(II) sample solution concentration, 400 mg/L of NC reagent

and reaction coil length of 100 cm. As a result, it was observed that the highest response of 4.3 cm was obtained at 157 μL of NC reagent volume, as shown in Fig. 6.

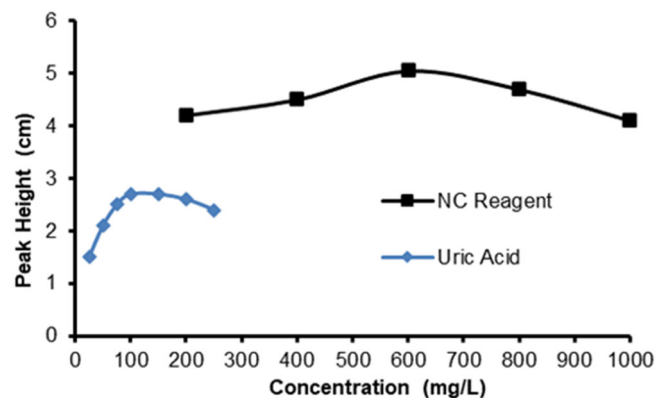

Fig 4. Effect of NC and uric acid concentration on the peak height

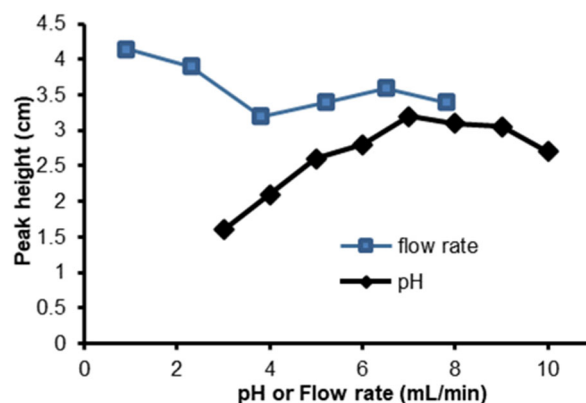

Fig 5. Effect of pH and flow rate on the peak height

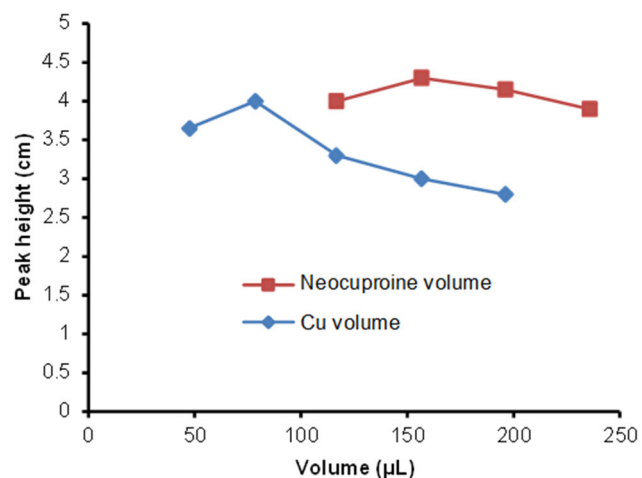

Fig 6. The relationship between the volume of Cu(II) and NC on the peak height

The Effect of Reaction Coil Length

The effect of the reaction coil length was studied at values of 50, 100, 150, and 200 cm (with a Teflon tube diameter of 0.5 mm), which produced peak height values of 4, 4.25, 4.5, and 3.65 cm, respectively. The study was conducted under optimum parameters: flow rate of carrier solution of 6.5 mL/min, pH 7, the uric acid concentration of 150 mg/L, 78.5 μ L of 15 mg/L Cu(II) sample solution, and 157 μ L of 400 mg/L NC reagent. It is clear from the results in Fig. 7 that the optimum coil length was 150 cm at the highest peak of 4.5 cm. The authors found that the increasing reaction coil length leads to an increase in the response because it facilitates good mixing for the components of the reaction. On the other hand, using very long reaction coils decreases response as the dispersion effect is happened but increases the time required for one analysis.

Neocuproine Reagent Concentration

The effect of the NC reagent concentration on the peak height was determined at values of 200, 400, 600, 800, and 1000 mg/L, in which the responses were 4.2, 4.5, 5.05, 4.7, and 4.1 cm, respectively, at the optimal conditions: flow rate of carrier solution of 6.5 mL/min, pH 7, the uric acid concentration of 150 mg/L, 78.5 μ L of 15 mg/L Cu(II) sample solution, 157 μ L of the NC reagent and reaction coil length of 150 cm. As shown in Fig. 4, it was observed that the highest response of 5.05 cm was obtained at the NC reagent concentration of 600 mg/L.

Compared to other techniques that are based on the reaction between Cu(II) and the NC reagent, there are several advantages that can be obtained by using the flow injection unit designed to determine Cu(II). It is

important to show that this work is characterized by utilizing a low concentration of NC reagent of 600 mg/L and a small volume of NC at 157 μ L. Furthermore, the current merging-zone flow injection unit requires a tiny volume of the Cu(II) sample of 78.5 μ L. Table 1 shows the comparison between the current non-consumptive new analysis unit for the determination of copper with other methods that are based on the same reaction.

The optimal conditions required by the new unit designed to determine Cu(II): the appropriate voltage of recorder, uric acid concentration, pH of the carrier solution, flow rate, Cu and NC volume, reaction coil length, and NC concentration are shown in Table 2.

Calibration Curve

The Cu(II) calibration curve was constructed by performing measurements at the optimal conditions. A series of Cu(II) concentrations were prepared to calculate the calibration graph, as shown in Fig. 8. The calibration curve indicated linearity of the Beer's law over

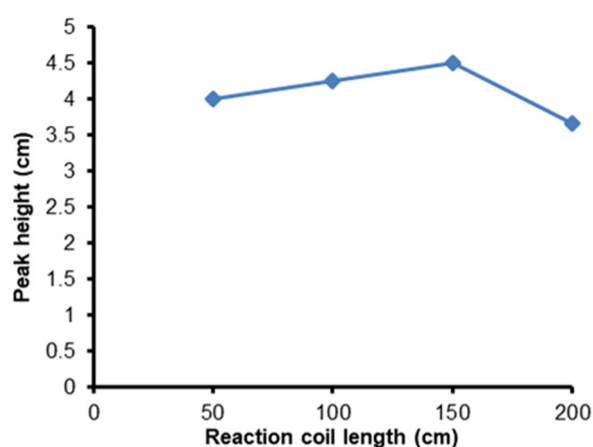

Fig 7. The relationship between reaction coil length and peak height

Table 1. Comparison of the present FIA unit to other analytical techniques for the determination of copper(II)

Method	Reagent (mg/L)	Reagent (μ L)	Cu (μ L)	Range (mg/L)	Ref.
Thermal lensing	1040	1000	500	0.6–63	[8]
FIA	832	400	100	-	[10]
Spectrophotometric	4160	219	220	-	[11]
Spectrophotometric	160	1000	1000	0.006–0.3	[28]
LLE-Spectrophotometric	880	250	5000	2.2–12.2	[29]
Merging-Zone FIA	600	157	78.5	0.4–40	current work

Table 2. Parameters estimate to optimize the FIA unit for determining Cu(II)

Parameter	Estimate range	Selected value
The recorder voltage (volt)	0.2–2	0.2
Uric acid concentration (mg/L)	25–250	150
The pH of the carrier solution	3–10	7
Flow rate (mL/min)	0.9–7.8	6.5
copper(II) volume (μL)	47.1–196.25	78.5
Neocuproine volume (μL)	117–235.5	157
Length of reaction coil (cm)	50–200	150
Neocuproine (mg/L)	200–1000	600

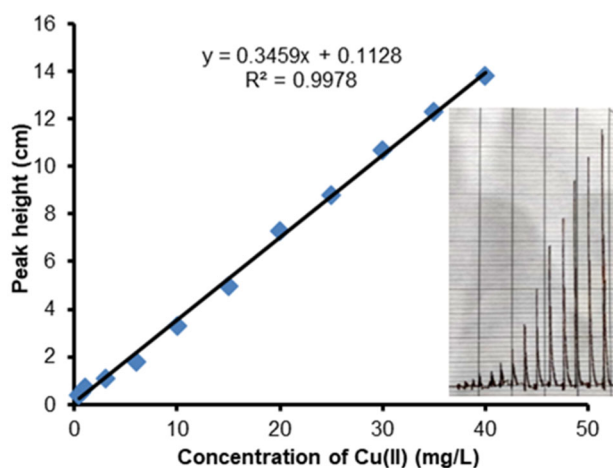
**Fig 8.** Calibration curve at optimum conditions: flow rate of carrier solution (6.5) mL/min, pH (7), the uric acid concentration 150 mg/L, 78.5 μL of Cu(II) sample solution, 157 μL of 600 mg/L NC reagent and reaction coil length 150 cm

the range of 0.4–40 mg/L ($r^2 = 0.9978$) with average standard deviation of 0.037 and average RSD of 1.14%. The detection limit ($S/N = 3$) was 0.1 mg/L, and the quantification limit ($S/N = 10$) was 0.3 mg/L. Molar absorptivity and Sandell's sensitivities were 1.661×10^5 L/mol cm and $0.0028 \mu\text{g}/\text{cm}^2$, respectively.

Repeatability

Repeatability was determined by repeating injections of the Cu(II) sample at least five times. The target of this study was to determine the precision of the measurement and the unit's efficiency. Using the optimum conditions, seven consecutive injections of the copper solution concentration 5, 15, and 25 mg/L of

Cu(II) were used to study the repeatability of injections. For these concentrations, the relative standard deviation values were 2.31, 0.63, and 0.50%, respectively. The obtained results shown in Table 3 display the efficiency and precision of the new flow injection unit design for the determination of Cu(II).

Dispersion Coefficient (D)

At optimum conditions, two measurements were done to determine the dispersion coefficient. The first experiment involved mixing the reaction components in a beaker outside the flow injection unit while keeping the volume ratio at 1:2 of Cu(II):NC reagent. Then 15 mL of 150 mg/L uric acid was added to prepare a suitable amount of carrier solution for aspiration into the flow injection unit. In this situation, the response represented H^0 . The second experiment involved the injection of the components of the reaction into their specified loops in the valve, in which the carrier solution was 150 mg/L of uric acid. The response was referred to as H_{max} and was considered as the original peak produced from the injection process. The coefficient of dispersion (D) was calculated by dividing H^0 by H_{max} [30-31]. The values of the dispersion coefficient were 1.8, 1.627, and 1.318 for the three concentrations of Cu(II), namely 5, 15, and 25 mg/L, respectively, as shown in Table 4.

Table 3. Repeatability ($n = 7$) at 5, 15, 25 mg/L of Cu(II)

Cu(II) (mg/L)	5	15	25
Peak height (cm)	1.6	5.05	8.8
	1.6	5	8.8
	1.5	5.05	8.7
	1.55	5.1	8.75
	1.6	5	8.8
	1.6	5.05	8.7
	1.55	5.05	8.8
SD	0.036	0.031	0.044
RSD%	2.31	0.63	0.50

Table 4. Dispersion coefficient

The concentration of Cu(II) (mg/L)	5	15	25
Peak height (cm), (H^0)	2.7	8.3	11.6
Peak height (cm), (H_{max})	1.5	5.1	8.8
Dispersion coefficient	1.80	1.62	1.31

Table 5. Comparison sampling throughput of the present FIA unit to other analytical techniques for determination of Cu(II)

Method	Sampling throughput (h ⁻¹)	Reaction time (min)	Ref.
Spectrophotometric	-	1	[28]
FIA-SPE- FAAS	25	2	[35]
SPE- FAAS	12	5	[36]
SFODME-FI-FAAS	6	10	[37]
Voltammetry	4	15	[38]
ICP-MS	10	-	[39]
Merging-zone FIA	69	52 sec	Present work

Table 6. Recovery and percentage error for determination Cu(II)

Taken (mg/L)	Response (cm)	Found (mg/L)	E	E%	Recovery
30	10.6	30.318	-0.010	-1.061	98.93
20	7.2	20.489	-0.024	-2.445	97.55
10	3.4	9.503	0.049	4.96	104.96

Dead Volume

The first step to determine the dead volume was the loading of the distilled water instead of the Cu(II) sample solution. The second step was loading distilled water instead of NC reagent solution in their loops. In these two steps, no peak was observed, but when the reaction components were injected into the loops, the peak was clearly noticeable. The carrier solution in both steps was 150 mg/L of uric acid under the optimum conditions. Therefore, this study indicates that no volume of Cu(II) sample solution or NC reagent solution remained in their loops before the loading of the next measurement. Therefore, the homemade valve worked with zero dead volume, indicating that this new flow injection unit is highly efficient. In previous articles, many designs of homemade valves accomplished operation with zero dead volume [32-34].

Sampling Throughput

The injection of all reaction components in the loops of the homemade valve required 25 sec. The required time for the peak to start from the baseline to the maximum peak height and back again to the baseline by the washing process was 52 sec (including injection of the components). Therefore, the sampling rate of the flow injection unit was 69 samples per hour. The comparison

of the sampling of the current FIA unit to other analytical techniques for the determination of Cu(II) is shown in Table 5.

Application in Aqueous Solution

The purpose of this experiment was to develop an application to determine copper in aqueous solutions. The prepared samples were taken without treatment and were analyzed with the new merging-zone flow injection technique. Table 6 shows satisfactory results for three prepared concentrations at a relative standard deviation of less than 5%. In addition, the table also shows a good agreement between the actual concentrations of Cu(II) and the concentration obtained from the calibration curve of the designed unit at the recovery rate of 100% ± 4.9.

CONCLUSION

A simple, fast, inexpensive, and feasible unit was developed to determine Cu(II) using the flow injection system with the merging-zone technique. The simplicity and speed of this new design involved a direct redox reaction between Cu(II) and uric acid, followed by an instantaneous reaction of Cu(I) with the NC reagent. The unit had good sampling throughput compared to other techniques. The homemade valve included a merging zone that reduced the volume of the Cu(II)

sample and NC reagent. The homemade valve was observed to have many advantages, namely: easy handling, high precision, low-cost, zero dead volume, and nearly no maintenance. The repeatability of measurements for this system was accurate at a very low relative standard deviation. Therefore, this new unit is dependable for determining Cu(II) in aqueous solution samples at a wide concentration range.

■ REFERENCES

- [1] Abdel-Raouf, M.S., and Abdul-Raheim, A.R., 2017, Removal of heavy metals from industrial waste water by biomass-based materials: A review, *J. Pollut. Eff. Control*, 5 (1), 1000180.
- [2] Ghorpade, A., and Ahammed, M.M., 2018, Water treatment sludge for removal of heavy metals from electroplating wastewater, *Environ. Eng. Res.*, 23 (1), 92–98.
- [3] Yu, J.S., Kim, S.H., Man, M.T., and Lee, H.S., 2018, Synthesis and characterization of water soluble fluorescent copper nanoparticles, *Appl. Sci. Convergence Technol.*, 27 (4), 75–77.
- [4] Jiang, T., Xie, D., Wu, J., He, H., Wang, H., Wang, N., Zhu, Z., Wang, Y., and Yang, T., 2020, Association between serum copper levels and prevalence of hyperuricemia: A cross-sectional study, *Sci. Rep.*, 10 (1), 8687.
- [5] Krivorotova, T., and Sereikaite, J., 2014, Determination of fructan exohydrolase activity in the crude extracts of plants, *Electron. J. Biotechnol.*, 17 (6), 329–333.
- [6] Dontha, S., 2016, A review on antioxidant methods, *Asian J. Pharm. Clin. Res.*, 9 (8), 14–32.
- [7] Zhang, G.Q., Li, Y.S., and Gao, X.F., 2018, An asynchronous-alternating merging-zone flow-injection gold nanoparticles probe method for determining anti-diabetic pioglitazone hydrochloride medicine, *New J. Chem.*, 42 (6), 4337–4343.
- [8] Proskurnin, M.A., Chernysh, V.V., Pakhomova, S.V., Kononets, M.Y., and Sheshenev, A.A., 2002, Investigation of the reaction of copper(I) with 2,9-dimethyl-1,10-phenanthroline at trace level by thermal lensing, *Talanta*, 57 (5), 831–839.
- [9] Gaál, A., Garay, T.M., Horváth, I., Máthé, D., Szöllösi, D., Veres, D.S., Mbuotidem, J., Kovács, T., Tóvári, J., Bergmann, R., Strelí, C., Szakács, G., Mihály, J., Varga, Z., and Szoboszlai, N., 2020, Development and in vivo application of a water-soluble anticancer copper ionophore system using a temperature-sensitive liposome formulation, *Pharmaceutics*, 12 (5), 466.
- [10] Emir, G., Dilgin, Y., and Apak, R., 2020, A new redox mediator (cupric-neocuproine complex)-modified pencil graphite electrode for the electrocatalytic oxidation of H₂O₂: A flow injection amperometric sensor, *ChemElectroChem*, 7 (3), 649–658.
- [11] Koga, T., Sakata, Y., and Terasaki, N., 2019, Accumulation and analysis of cuprous ions in a copper sulfate plating, *J. Visualized Exp.*, 145, e59376.
- [12] Skrovankova, S., Mlcek, J., Sochor, J., Baron, M., Kynicky, J., and Jurikova, T., 2015, Determination of ascorbic acid by electrochemical techniques and other methods, *Int. J. Electrochem. Sci.*, 10, 2421–2431.
- [13] Morosanova, M.A., and Morosanova, E.I., 2017, Silica-titania xerogel doped with Mo,P-heteropoly compounds for solid phase spectrophotometric determination of ascorbic acid in fruit juices, pharmaceuticals, and synthetic urine, *Chem. Cent. J.*, 11 (1), 3.
- [14] Losev, V.N., Didukh, S.L., Trofimchuk, A.K., and Zaporozhets, O.A., 2014, Adsorption–photometric and test determination of copper using silica gel sequentially modified with polyhexamethylene guanidine and bathocuproinedisulphonic acid, *Adsorpt. Sci. Technol.*, 32 (6), 443–452.
- [15] Ayaz, S., Dilgin, Y., and Apak, R., 2020, Flow injection amperometric determination of hydrazine at a cupric-Neocuproine complex/anionic surfactant modified disposable electrode, *Microchem. J.*, 159, 105457.
- [16] Ribeiro, J.P.N., Magalhães, L.M., Reis, S., Lima, J.L.F.C., and Segundo, M.A., 2011, High-throughput total cupric ion reducing antioxidant

- capacity of biological samples determined using flow injection analysis and microplate-based methods, *Anal. Sci.*, 27 (5), 483–488.
- [17] Brasil, M.A.S., and Reis, B.F., 2017, An automated multicommuted flow analysis procedure for photometric determination of reducing sugars in wine employing a directly heated flow-batch device, *J. Braz. Chem. Soc.*, 28 (10), 2013–2020.
- [18] Kukoc-Modun, L., Tsikas, D., Biocic, M., and Radić, N., 2015, Flow injection analysis of *N*-acetyl-L-cysteine based on the reduction of copper(II)-neocuproine reagent, *Anal. Lett.*, 49 (5), 607–617.
- [19] Chandramouleeswaran, S., and Ramkumar, J., 2018, Insight of spectrophotometric determination using 4-(2-pyridylazo) resorcinol: Application of stop flow injection analysis, *Chem. Sin.*, 9 (2), 605–608.
- [20] Kraljević, T., Jelić-Knezović, N., Marković Boras, M., and Ćurlin, M., 2020, Spectrophotometric hybrid flow system for determination of *N*-acetyl-L-cysteine in pharmaceuticals, *IOSR J. Appl. Chem.*, 13 (5), 27–34.
- [21] Omarova, S., Demir, S., and Andac, M., 2018, Development of a new spectrophotometric based flow injection analysis method for the determination of copper (II), *J. Taibah Univ. Sci.*, 12 (6), 820–825.
- [22] Segundo, M.A., Tóth, I.V., Magalhães, L.M., and Reis, S., 2015, “Automatic flow injection analysis (FIA) determination of total reducing capacity in serum and urine samples” in *Advanced Protocols in Oxidative Stress III*, Armstrong, D., Eds., Humana Press, New York, 277–284.
- [23] Marques, S.S., Magalhães, L.M., Tóth, I.V., and Segundo, M.A., 2014, Insights on antioxidant assays for biological samples based on the reduction of copper complexes—the importance of analytical conditions, *Int. J. Mol. Sci.*, 15 (7), 11387–11402.
- [24] da Silva, P.A.B., de Souza, G.C.S., Paim, A.P.S., and Lavorante, A.F., 2018, Spectrophotometric determination of reducing sugar in wines employing in-line dialysis and a multicommuted flow analysis approach, *J. Chil. Chem. Soc.*, 63 (2), 3994–4000.
- [25] Viganor, L., Howe, O., McCarron, P., McCann, M., and Devereux, M., 2017, The antibacterial activity of metal complexes containing 1,10-phenanthroline: Potential as alternative therapeutics in the era of antibiotic resistance, *Curr. Top. Med. Chem.*, 17 (11), 1280–1302.
- [26] da Silva, J.C., Suarez, W.T., and de Oliveira Krambeck, F.M., 2018, Flow-injection spectrophotometric determination of methimazole in pharmaceuticals using a charge-transfer complex Cu(I)-neocuproine, *J. Anal. Chem.*, 73 (3), 243–248.
- [27] Taha, D.N., and Obaid, Z.S., 2016, Designing flow injection unit for chromates determining, *Res. J. Pharm., Biol. Chem. Sci.*, 7 (6), 2242–2251.
- [28] Babayeva, K., Demir, S., and Andac, M., 2017, A novel spectrophotometric method for the determination of copper ion by using a salophen ligand, *N,N*-disalicylidene-2,3-diaminopyridine, *J. Taibah Univ. Sci.*, 11 (5), 808–814.
- [29] Çağlar, Y., and Saka, E.T., 2017, Ionic liquid based dispersive liquid-liquid microextraction procedure for the spectrophotometric determination of copper using 3-dimethylamino rhodanine as a chelating agent in natural waters, *Karbala Int. J. Mod. Sci.*, 3 (4), 185–190.
- [30] Kulkarni, A.A., and Vaidya, I.S., 2015, Flow injection analysis: An overview, *J. Crit. Rev.*, 2 (4), 19–24.
- [31] Yaseen, S.M., Qassim, B.B., and Al-Lami, N.O., 2020, Spectrophotometric determination of Co(II) in vitamin B12 using 2-(biphenyl-4-yl)-3-((2-(2,4-dinitrophenyl) hydrazono)methyl) imidazo [1,2-a]pyridine as ligand by flow injection–merging zone analysis, *Al-Nahrain J. Sci.*, 23 (3), 24–38.
- [32] Farhood, A.S., Majeed, A.S., Ali, L.A.M., and Taha, D.N., 2017, Semi-automated flow injection method for the determination of iron (II) by 1,10-phenanthroline, *Orient. J. Chem.*, 33 (6), 3112–3120.
- [33] Farhood, A.S., Ali, L.A.M., and Ali, F.F., 2017, Determination of aniline blue dye by flow injection analysis with home made valve, *Orient. J. Chem.*, 33 (2), 944–950.
- [34] Majeed, A.S., Farhood, A.S., Ali, L.A.M., and Taha, D.N., 2017, Home-made micro valve for determining malachite green dye by flow injection analysis, *Indones. J. Chem.*, 17 (2), 248–255.

- [35] Cassella, R.J., Magalhães, O.I., Couto, M.T., Lima, E.L.S., Neves, M.A.F.S., and Coutinho, F.M.B., 2005, Synthesis and application of a functionalized resin for flow injection/F AAS copper determination in waters, *Talanta*, 67 (1), 121–128.
- [36] Mashhadizadeh, M.H., Pesteh, M., Talakesh, M., Sheikhshoae, I., Ardakani, M.M., and Karimi, M.A., 2008, Solid-phase extraction of copper (II) by sorption on octadecyl silica membrane disk modified with a new Schiff base and determination with atomic absorption spectrometry, *Spectrochim. Acta, Part B*, 63 (8), 885–888.
- [37] Şahin, Ç.A., and Tokgöz, İ., 2010, A novel solidified floating organic drop microextraction method for preconcentration and determination of copper ions by flow injection flame atomic absorption spectrometry, *Anal. Chim. Acta*, 667 (1-2), 83–87.
- [38] Mohadesi, A., and Taher, M.A., 2007, Voltammetric determination of Cu(II) in natural waters and human hair at a meso-2,3-dimercaptosuccinic acid self-assembled gold electrode, *Talanta*, 72 (1), 95–100.
- [39] Wainwright, P., Wadey, D., and Cook, P., 2018, An inductively coupled plasma mass spectrometry method for relative free copper determination and generation of a paediatric reference interval, *Ann. Clin. Biochem.*, 55 (4), 485–490.