

## DIODE-LASER BASED PHOTO-ACOUSTIC SPECTROSCOPY IN ATMOSPHERIC NO<sub>2</sub> DETECTION

Mitrayana<sup>1</sup>, T. Pierera<sup>2</sup>, B.W.M. Moeskops<sup>2</sup>, S. Persijn<sup>2</sup>, H. Naus<sup>2</sup>, F.J.M. Harren<sup>2</sup>, M.A.J. Wasono<sup>1</sup>, Muslim<sup>1</sup>, and W. Rochmah<sup>3</sup>

<sup>1</sup>Atomic and Nuclear Physics Lab. Physics Dept. Gadjah Mada University Indonesia  
email address: [mitrayana@ugm.ac.id](mailto:mitrayana@ugm.ac.id)

<sup>2</sup>Molecular and Laser Physics Dept. Radboud University of Nijmegen, the Netherlands

<sup>3</sup>Medical Faculty of Gadjah Mada University Indonesia

### ABSTRACT

We have developed a simple, low cost, and compact NO<sub>2</sub> detection system. It's based on photoacoustic spectroscopy (PAS) method uses a diode laser as a source of radiation. The PAS system has a detection limit of 10 ppbv for NO<sub>2</sub>. With this set-up we were able to detect the NO<sub>2</sub> concentration from urban air near our campus. We have also investigated the NO<sub>2</sub> dissociation effect on the PAS system via NO measurements using a direct absorption spectroscopy method on quantum cascade laser(QCL) system.

**Keywords:** photoacoustic spectroscopy

Makalah diterima 2 September 2007

### 1. INTRODUCTION

Nitrogen dioxide (NO<sub>2</sub>) belongs to the family of nitrogen oxides (NO<sub>x</sub>). It occurs naturally in the atmosphere, but it is also produced anthropogenically by e.g. burning of gasoline, coal, oil and other fuels as well as in power plants and burning of natural material (U.S. Environmental Protection Agency, 1999). The ambient concentrations of nitrogen dioxide are influenced by meteorological conditions like wind speed, temperature and precipitation, and result in both environmental and health effects (World Health Organization, 2000). The gas plays an important role in the atmospheric reactions that generate ozone which is an important contributor to air pollution and smog formation. NO<sub>2</sub> promotes the formation of acid aerosols, which pollute water and harm vegetation, as well as buildings. It is also associated with visibility degradation (Matooane, 2000). In The Netherlands, the

largest contribution to the emission of NO<sub>x</sub> is made by traffic (65%). Nitrogen dioxide is toxic by inhalation. Long-term exposure to NO<sub>2</sub> at concentrations above 40–100 µg/m<sup>3</sup> causes adverse health effects that includes irritation of the eyes, skin and the respiratory system. It also affects the immune system resulting in low resistance to infection and cause genetic damage (Matooane, 2000). The current world health organization (WHO) guideline values for NO<sub>2</sub> for Europe are: a 1-hour level of 200 µg/m<sup>3</sup> (0.11 ppmv) and an annual average of 40 µg/m<sup>3</sup> (0.021 to 0.026 ppmv). Nitrogen dioxide concentrations in the air have remained around 45µg/m<sup>3</sup> which equal to the currently maximum allowed recommended concentration. Nitrogen dioxide levels are highest in urban areas and along major road networks. This reflects that vehicle emissions are still the greatest source of NO<sub>x</sub> gases ([http://www.environment-agency.gov.uk/yourenv/eff/1190084/air/1158715/1162725/?lang=\\_e](http://www.environment-agency.gov.uk/yourenv/eff/1190084/air/1158715/1162725/?lang=_e)). Because NO<sub>2</sub> is involved in

numerous reactions which affect atmospheric composition, environmental degradation, human health problems and it can be transported over long distances, knowing the concentration of NO<sub>2</sub> in the atmosphere is important.

Recently, efforts toward the development of simple and reliable devices have been increased with the aim to control air pollution and to detect toxic gases at low levels in the air, in the field of domestic and industrial applications. Laser based trace gas sensors have been used to monitor NO<sub>x</sub> emissions from individual vehicles (Shorter, et. al., 2005), as well as variations in air pollution over cities (Altuzar, et.al., 2003; Altuzar, et.al., 2005), thereby demonstrating that they can make contributions to manage air quality. In this paper, we present a simple, low cost, compact and standalone NO<sub>2</sub> detection system based on resonant photoacoustic spectroscopy (PAS). The performance of the diode laser driven system was explored and the sensor was applied to monitor the NO<sub>2</sub> level in the atmosphere. In addition, NO, as a product of NO<sub>2</sub> dissociations, was monitored using a direct absorption spectroscopy methods on quantum cascade (QCL) laser based detector.

## 2. MATERIALS AND METHODS

A sketch of the setup is shown in Figure 1. The cell is shown schematically; the real dimensions are given in the text.

The photoacoustic (PA) cell resonator is cylindrical with buffers attached at both ends and 3 microphones (Knowless EK3024, sensitivity of 22 mV/Pa and electrical noise 29 nV/ $\sqrt{\text{Hz}}$ ) placed near its midpoint. The internal diameter of the resonator is 6 mm and its length is 300 mm. The buffer has a 40 mm diameter and a length 50 mm.. The cell had one inlet and two outlet ports. The gas inlet port was connected to the centre of the resonator via an acoustic notch filter of  $\frac{1}{4} \lambda$ , in order to suppress the noise in line with the trace gas flow optimally at the resonance frequency of the PA cell.

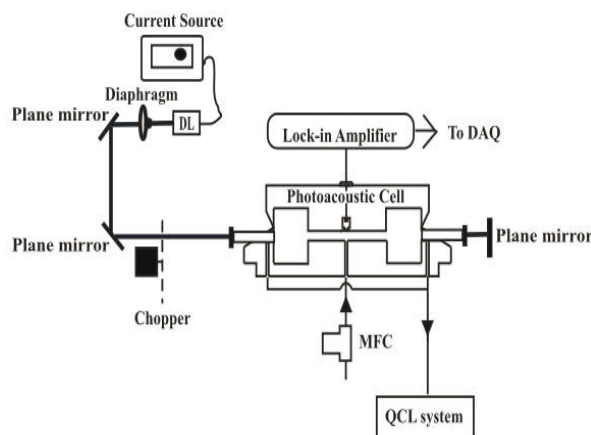

**Figure 1. – Photoacoustic spectroscopy (PAS) system experimental setup.** The laser beam from the diode laser (DL) is passed twice through the photoacoustic (PA) cell by using a plane mirror behind it. The gas output from PA cell goes to the QCL system. DL: Diode laser, MFC: mass flow controller, DAQ: data acquisition card, QCL: quantum cascade laser

The detection system of a resonant PA experiment for trace-gas measuring is generally based on synchronous detection with lock-in amplifiers in order to obtain a good signal-to-noise ratio. To determine the resonance frequency of the photoacoustic cell, we varied the modulation frequency  $f_m$  to scan the profile of the resonance peak and precisely determine its maximum. The amplitude of the frequency spectrum at the laser-beam chopping frequency  $f_m$  was stored and the procedure was repeated for different repetition rates around the cell's resonance with steps adequate for a good definition of the maximum, depending on the cavity  $Q$ -factor. The recorded amplitude and frequency values determined the PA peak, which shows a Lorentzian profile. For the following experiments the modulation frequency was set to the optimum value found from Figure 2,  $(565 \pm 1)$  Hz.

The first application test of the PA system is to measure the NO<sub>2</sub> gas traces in urban air from road traffic near our campus. For this work we used a diode laser operating at 415 nm with typical cw output powers of 42

mW, FWHM < 1,5 nm and the beam width is around 1,5 mm. Urban air was continuously sampled at 1 m from the road side at a height of 3 m and flushed through the PA cell via a 40 m long Teflon tubing ( $\varnothing$  2 mm) at 15 l/h.

The wavelength of the laser is 415 nm. At this wavelength NO<sub>2</sub> is dissociated strongly to NO (Coroiu, et. al., 2006). To show the dissociation effect we used a direct absorption spectroscopy methods on QCL (Quantum Cascade Laser) system for detection of NO that was generated by the PAS system. For this purpose we connected the gas outlet of the PA cell to multi-pass cell in the QCL system Moeskops, et. al., 2006. During the experiments the pressure inside the cell was kept 100 mbar by a pressure controller and a pump. After the absorption cell the laser beam was focused onto a fast, liquid-nitrogen cooled detector (KV-104, Kolmar Technologies).

### 3. RESULTS AND DISCUSSIONS

With this setup (Figure 1) we obtained values for the resonance frequency of the PA cell of  $565 \pm 1$  Hz and a  $Q$  factor of  $13,1 \pm 0,2$  (Figure 2). The laser power in the PA cell is 42 mW. Noise from the electronic equipments and gas flow rate was around  $29 \text{ nV}/\sqrt{\text{Hz}}$ . The background signal of the system when filled with N<sub>2</sub> was  $(180 \pm 5)$  ppbV, so from the noise and background data we get a detection limit of 10 ppbV.

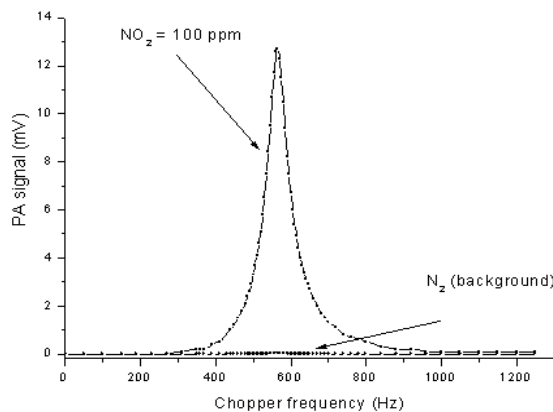

Figure 2- Resonance frequency of the PA cell

The characterization and calibration of the PA system is shown in Figures 3. From the figures we can infer that dissociation occurs in the PA cell since at the PA signal is reduced at low flow rates. To proof that this effect is due to dissociation we used the QCL system to measure the NO concentration in the gas outlet of the PA cell (Figure 5). From Figure 3 it is clear that by operating the system at a flow rate greater than 10 l/h, our measurement of the atmospheric NO<sub>2</sub> concentration is linear and is not distorted by dissociation effects.

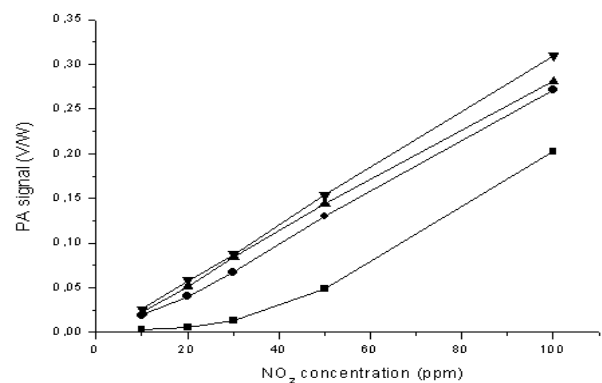

Figure 3. – Values of PA signal vs. NO<sub>2</sub> concentration in N<sub>2</sub> at different flow rates at a laser power of 42 mW. : 2 l/h; ? 10 l/h; ? 15 l/h; ? 20 l/h

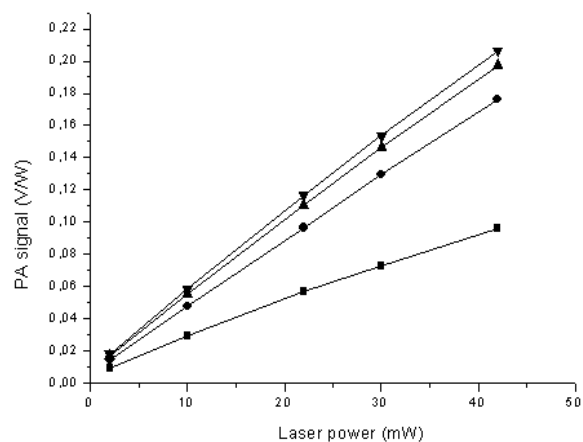
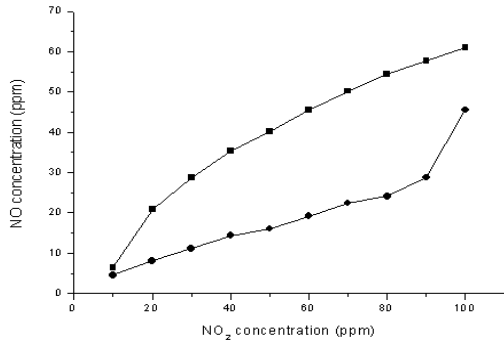
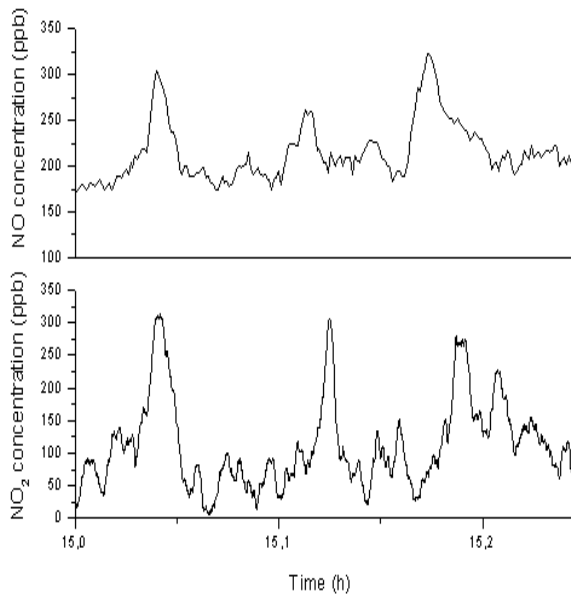

Figure 4. – Values for PA signal vs. laser power at different gas flow rates of the 100 ppm NO<sub>2</sub> concentration in N<sub>2</sub>. : 2 l/h; ? 10 l/h; ? 15 l/h; ? 20 l/h



**Figure 5 - NO vs. NO<sub>2</sub> concentration measured by the QCL and photoacoustic system, respectively. □ NO<sub>2</sub> in N<sub>2</sub>; ○ NO<sub>2</sub> in air. The gas flow rate in the PA system is 15 l/h**



**Figure 6. – Values for NO<sub>2</sub> and NO concentration from urban air around 3:00 PM June 15<sup>th</sup>, 2006**

Figure 5 shows the dissociation effect that occurs in the PA cell. This is clear with the NO signal appear in the QCL system when the outlet NO<sub>2</sub> gas from the PA cell is filled in the multiple pass cell in the QCL system, with the following reaction  $\text{NO}_2 + h\nu \rightarrow \text{NO} + \text{O}(\text{^3P})$  (Atkinson, et.al., 2004). We can see that NO

signal is not linear to the NO<sub>2</sub> (in the Nitrogen and air) signal. Also we can see the NO signal from NO<sub>2</sub> in N<sub>2</sub> is higher than NO<sub>2</sub> in air, that is because same reaction from  $2\text{NO} + \text{O}_2 \rightarrow 2\text{NO}_2$  (Atkinson, et.al., 2004).

Figure 6 shows the results from the parallel measurements between the PAS system and the QCL system from the out side air. Around 3:00 PM we obtained the synchronous signal that is NO<sub>2</sub> signal from the PA system and NO signal from the QCL system. To demonstrate that the PA system is suitable for long-term atmospheric measure-ments we sampled air from a nearby roadside for 2 days, as is shown in Figure 7. Also in the inset of the graphic we can see the high NO<sub>2</sub> concentration during the rush hour that means heavy traffic of cars, buses and trucks in the same time.

The average of NO<sub>2</sub> concentration for 12 hours (July 12<sup>th</sup>, 2006 at 5:42 PM to July 13<sup>rd</sup>, 2006 at 6:15 AM) in urban air/ traffic road inside the campus is  $(76 \pm 19)$  ppbv, that are similar to the values that Slezak *et al.* (75 ppbv) got near their campus (Slezak, et.al., 2003).

#### 4. CONCLUSIONS

We have developed the diode laser-based photoacoustic spectroscopy (PAS) system that is simple, low cost, and compact and stand-alone detection system. The system has a detection limit of 20 ppbv for the NO<sub>2</sub>. With this system we were able to detect the NO<sub>2</sub> concentration from urban air near our campus. We have also investigated the NO<sub>2</sub> dissociation effect of the system with NO measurements with a QCL system Moeskops, et. al., 2006. Furthermore, trace gas detection using the diode laser-base PAS system has proved to its capability in environmental monitoring and shows promise for other applications in life sciences and medical diagnostics as well.

#### Acknowledgment

Thank you very much to Delta (RUN) for supporting in this research, Cor and Petter for help in technical equipments.

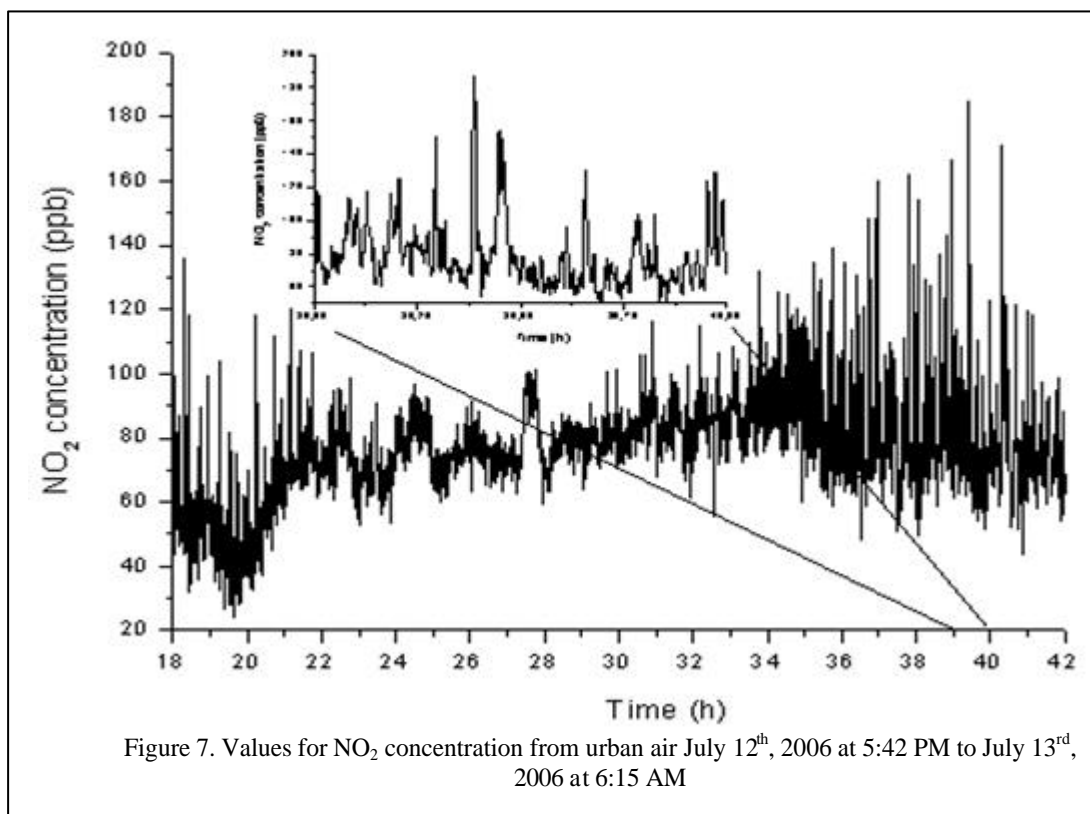

## REFERENCES

- Altuzar, V., S. A. Tomas, O. Zelaya-angel, and F. Sanchez-Sinencio., 2003. Atmospheric pollution profiles in Mexico City in two different seasons. *Review of Scientific Instruments*, 74:500–502.
- Altuzar, V., S. A. Tomas, O. Zelaya-angel, and F. Sanchez-Sinencio, J.L. Arriaga, 2005. Atmospheric ethene concentrations in Mexico City: Indications of strong diurnal and seasonal dependences. *Atmospheric Environment*, 39:5219–5225.
- Atkinson, R., D.L. Baulch, R. A. Cox, J.N. Crowley, R.F. Hampson, R.G. Hynes, M.E. Jenkin, M.J. Rossi, and J. Troe, 2004. Evaluated kinetic and photochemical data for atmospheric chemistry: Volume I – gas phase reactions of O<sub>x</sub>, HO<sub>x</sub>, NO<sub>x</sub> and SO<sub>x</sub> species. *Atmos. Chem. Phys.*, 4, 1461-1738.
- Coroiu, A.M. D.H. Parker, G.C. Groenenboom, J. Barr, IT. Novalbos, and B.J. Whitaker, 2006. Photolysis of NO<sub>2</sub> at multiple wavelengths in the spectral region 200–205 nm. *Eur. Phys. J.D.*, 38, 151 – 162.
- <http://www.environment-agency.gov.uk/yourenv/eff/1190084/air/1158715/1162725/?lang=e>, Enhanced Environmental Management, Report no. P5-1, Durban.
- Matooane, M., 2000. Report on Human Health Risk Assessment of Exposure to Sulphur Dioxide and Nitrogen Dioxide in the Greater Cato Manor-Durban. University of Natal, Durban. Lead Programme in Technologies for The Environmental Agency, 2006. Environmental facts and figures.

- Moeskops, B.W.M., S.M. Cristescu, and F.J.M. Harren, 2006. Sub-part-per-billion monitoring of nitric oxide by use of wavelength modulation spectroscopy in combination with a thermoelectrically cooled, continuous-wave quantum cascade-laser. *Optics Letters* Vol. 31, No. 6, March 15, 823-825.
- Shorter, J. H., S. Herndon, M. S. Zahniser, D. D. Nelson, J. Wormhoudt, K. L. Demerjian, and C. E. Kolb., 2005. Real-time measurements of nitrogen oxide emissions from in-use New York City transit buses using a chase vehicle. *Environmental Science & Technology*, 39(20):7991–8000.
- Slezak, V., G. Santiago, A. Peuriot, 2003. Photoacoustic detection of NO<sub>2</sub> traces with CW and pulsed green lasers. *Optics and Lasers in Engineering*, 40, 33-41.
- U.S. Environmental Protection Agency, 1999. Air Pollution and Health Risk. Air Risk Information Support Centre. [http://www.epa.gov/ttn/uatw/3\\_90\\_022.htm](http://www.epa.gov/ttn/uatw/3_90_022.htm)
- World Health Organization, 2000. Nitrogen dioxide. In: Air Quality Guidelines for Europe. <http://www.who.int/en/>