

MICROCONTROLLER BASED HYDROGEN SULFIDE (H₂S) MONITORING IN BIOGAS SYSTEM

Diah Yuniarti¹, Sarjiya², Ambar Pertiwinigrum³

¹Kementerian Komunikasi dan Informatika, Jakarta

²Jurusan Teknik Elektro dan Teknologi Informasi, Fakultas Teknik, Universitas Gadjah Mada

³Jurusan Ilmu Hewan dan Industri, Fakultas Peternakan, Universitas Gadjah Mada

*Correspondence : life.fillium@gmail.com

Abstract

Energy issue, particularly related to fossil fuel, is one the main issues today. Biogas is a new and renewable energy issued in National Research Agenda (ARN) 2010-2014 to overcome the energy crisis problem. A so called purification process is used to remove contaminants in biogas, including H₂S in order to improve the standard requirement of biogas application. In this research, H₂S concentration in biogas system is measured and monitored by H₂S monitoring system.

The hardware system comprises of piping and microcontroller AVR 8535 systems while the software system comprises of codes written in Delphi 7.0 and Code Vision AVR Eval. The result of the system is displayed on LCD or computer to enable the monitoring process by operator. The monitoring of H₂S sensor responses will be carried out for recycled BFA size of 60+100 mesh and -200 mesh.

Experiment has been conducted for sensor warming up time and response time for H₂S and CH₄ sensor, calibration process for H₂S sensor and filter column. Based on sensor calibration experiment, transfer function of TGS825 sensor from calibration is $y = 0.0203x + 27.153$. The best adsorption model which represents BFA adsorption of biogas from tofu waste in the research is Thomas model.

Sejarah:

Diterima: 28 September 2012

Diterima revisi: 14 Januari 2013

Disetujui: 5 Februari 2013

Tersedia online: 31 Juli 2013

Keywords:

Biogas

H₂S concentration

microcontroller AVR 8535

adsorption model

1. Introduction

Energy issue, particularly related to fossil fuel, is one the main issues today. The depletion of oil reserve in the world has encouraged alternative energy research and innovation on fossil fuel substitution or complementary. Biogas is a new and renewable energy issued in National Research Agenda (ARN) 2010-2014 to overcome the crisis energy problem.

Biogas is the product of anaerobic digestion of organic matters composed mainly of methane (CH₄) and carbon dioxide (CO₂), with smaller amounts of water vapor and trace amounts of hydrogen sulfide (H₂S), and other impurities. Hydrogen sulfide is typically the most problematic contaminant because it is toxic and corrosive to most equipment. Additionally, combustion of H₂S leads to sulfur dioxide emissions, which have harmful environmental effects. Removing H₂S as soon as possible is recommended to protect downstream equipment, increase safety, and enable possible utilization of more efficient technologies such as micro turbines and fuel cells (Zicari, 2003).

A so called purification process is used to remove contaminants in biogas, including H₂S in order to improve the standard requirement of biogas application such as heating (boiler) and fuel of internal combustion engine. Thus, the monitoring of H₂S concentration in biogas is vital to ensure the biogas purification system performance in producing standard requirement of H₂S concentration for certain applications.

In this research, H₂S concentration in biogas system is measured and monitored by H₂S monitoring system. The system comprises of hardware and software combined together. The hardware system comprises of piping and electronic microcontroller elements while the software system comprises of codes written in Delphi 7.0 and Code Vision AVR Eval. The monitoring system is carried out by placing H₂S sensor in the biogas system. Output of the

sensor, measured as analog voltage, is processed by ADC in the microcontroller. The result is displayed on LCD or computer to enable the monitoring process by operator. The monitoring of H₂S sensor responses will be carried out for BFA size of 60+100 mesh and -200 mesh which are recycled. Recycling process of BFA is conducted by reheating BFA in an oven with temperature 110°C for four hours. The experiments are conducted for sensor warming up time and response time for H₂S and CH₄ sensor, calibration process for H₂S sensor and filter column. At the end, the adsorption model represent adsorption of BFA size variables among Adam Bohart's, Thomas's and Yan's are compared and analyzed.

2. Research Methodology

H₂S Monitoring System Design

The research location is at tofu waste biogas installation in Seyegan, Sleman, Yogyakarta. H₂S monitoring system comprises of H₂S measurement plant and H₂S electronic system. The filter column to purify biogas from bio digester is made of PVC with diameter 2.5" and height 30 cm. Biogas output from filter column flow through measurement plant. The piping configuration was established to enable biogas flow rate adjustment accordance to experiment requirement. Biogas from bio digester or the filter passes PVC tee connector and manual valve. After adjusting the flow rate through manual valve, biogas will pass through ¼" plastic connector and 1" PVC pipe. CH₄ sensor, H₂S sensor, and temperature and humidity sensor are placed in the end of PVC pipe to enable electronic measurement by microcontroller AVR ATMEGA8535. The H₂S measurement system plant diagram and H₂S measurement system plant diagram with filter column is given in Figure 1 dan Figure 2 respectively.

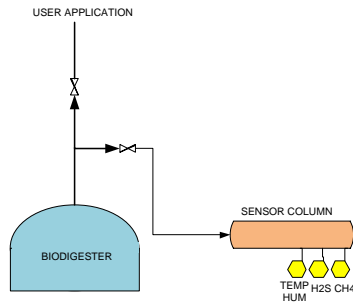

Figure 1. H₂S Measurement System Plant Diagram

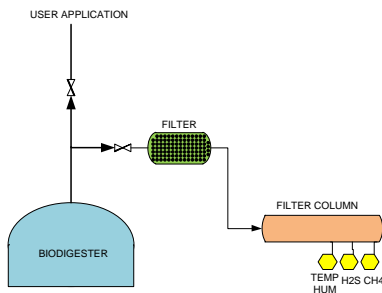

Figure 2. H₂S Measurement Plant Diagram with Filter Column

The block diagram of biogas flow from bio digester up to electronic system in the H₂S measuring system is given in Figure 3 while the actual hardware of the system is given in Figure 4.

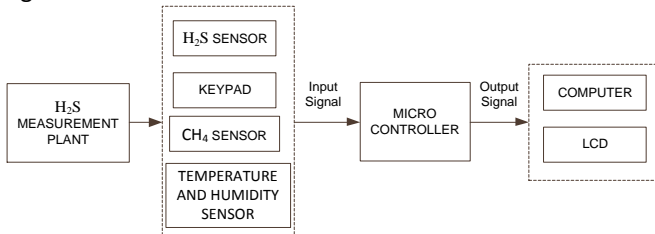

Figure 3. Block Diagram of H₂S Measuring System



Figure 4. Actual H₂S Monitoring System

Sensor calibration process is conducted by connecting the biogas output from the measurement plant to a plastic bottle with volume of 600 ml. The plastic bottle is filled by water up to half part of the bottle. Two orifices on the bottle are made to create input and output side to put plastic pipe. The input and output side of the plastic bottle is connected to the measurement plant. System diagram of sensor calibration is given in Figure 5.

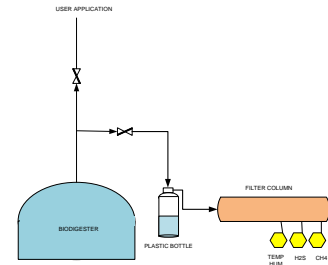

Figure 5. System Diagram of Sensor Calibration

The plastic bottle filled by water is used in the experiment to detain quick rate of H₂S concentration rate of biogas. After biogas flowing through the plastic bottle filled by water, its temperature and humidity relatively constant. Biogas coming out from the column attached with sensors is taken as sample. The sampling is taken by Balai Besar Teknik Kesehatan Lingkungan dan Pemberantasan Penyakit Menular Yogyakarta (BBTKL Yogyakarta) official.

They also prepare the sampling equipment. Then, sampling result is compared to result from H₂S sensor of the monitoring system. The sampling process rate is slower than the reading by sensor. Thus, means of two nearest value of sensor reading is compared to single value of sample taken. Beside H₂S value, CH₄, temperature and humidity values are also taken online to support data analysis. Compressed air is used to normalize the sensor response after saturation condition caused by high concentration of H₂S of the biogas.

3. Results And Discussion

Experiment has been conducted for sensor characteristic, sensor calibration and filter column. Sensor characteristic experiments comprises of sensor warming up time and response time for H₂S and CH₄ sensor and calibration equation for H₂S sensor.

Sensor Warming Up Time

Sensor warming up time is time needed for the sensor system to reach stable output from its initial warming up. Warming up time experiments for H₂S and CH₄ Sensor is given in Figure 6. The experiment is conducted in a normal atmosphere condition.

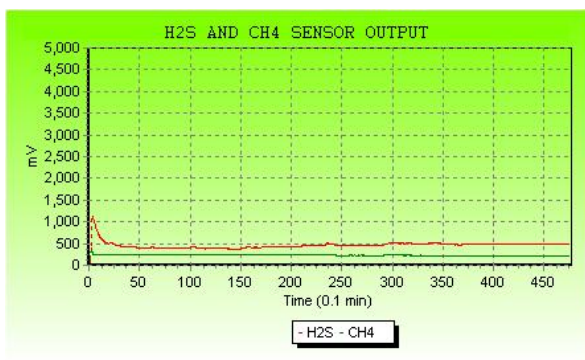

Figure 6. H₂S and CH₄ Sensor Warming Up Time

As seen in Figure 6, both H₂S and CH₄ sensors require several periods to be in their steady state condition from initial condition. The initial condition of the sensors is the condition before sensor supply is on. Thus, before the sensors can responds properly, warming process is necessarily required. Warming time required for H₂S sensor until it reaches its steady state is 32 minutes while CH₄ require less than 1 minute (41 seconds) to reach its steady state. In next experiments, the sensors are warmed for 1 hour.

Sensor Response Time

Response time is time needed for physical unit change measured. The sensor measurement process is started as the sensor responses in normal air condition. Afterwards, gas concentration is modified into larger value. It takes several periods for the sensor to reach its stabile output after the gas concentration changing.

The experiment conducted by previously warm up H₂S and CH₄sensors up one hour in a normal atmosphere condition. Then, after the voltage output value has relatively stabile, a number of biogas is drained to the measurement plant. The voltage output changes occurred is plotted in a Delphi 7.0 graph as seen in Figure 7. and Figure 8.

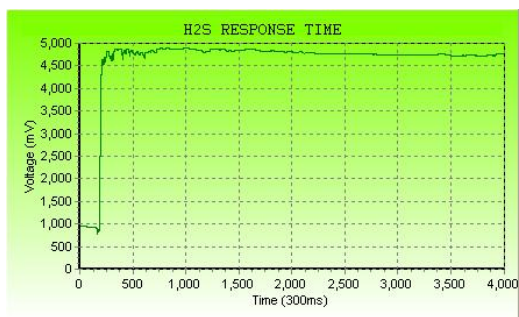

Figure 7. H₂S Sensor Response Time

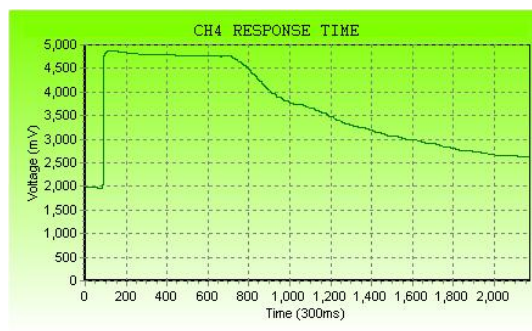

Figure 8. CH₄ Sensor Response Time

As seen in Figure 8, initially, H₂S sensor output voltage is relatively constant at 922 mV. Then, after a number of biogas is drained into the measurement plant, the output voltage value has quickly changed into larger value, average at 4800 mV. H₂S sensor response time to the concentration changes is nearly 10 ms. Mean while, in Figure 8, initially, CH₄ sensor output voltage position is at 1980 mV. Then, a sudden change of CH₄ concentration has also made sensor output voltage changes into around 4800 mV. The sensor response time is 125 ms. Generally, both sensor response time are less than 1 s. Sudden decrease of CH₄ concentration after 5 minutes has also made sensor output voltage value decreases. It can be seen that sensor response time to a larger CH₄ concentration is faster than sensor response time to a smaller CH₄ concentration.

H₂S Sensor Calibration

H₂S Sensor Calibration involves sampling taken by BBTKL. Transfer function equation of the sensor is analyzed by comparing the result between H₂S Sensor Reading and biogas sampling taken by BBTKL. The result is given in Table 1.

Table 1. Result Comparing Between LCD Reading and BBTKL Sampling

No.	H ₂ S Sensor Reading (ADC Value)	Voltage (mV)	BBTKL H ₂ S Sampling Result (ppm)	Temperature (°C)	RH (%)
1.	43	843.14	33.78	30.8	82
2.	104	2039.22	62.45	30.8	82
3.	109	2137.26	93.3	30.8	82
4.	226	4431.37	110.93	30.8	82

From H₂S sensor reading in mV and biogas sampling in ppm values as read in Table 1, a single equation line is created. Through linearization, approach equation of the line is obtained. The linear equation shows relation between H₂S concentration (ppm) and H₂S sensor output voltage (mV). Graphical data of the relation is given in Figure 9. The equation is:

$$y = 0.0203x + 27.153 \dots\dots\dots (1)$$

Where $y = \text{H}_2\text{S}$ concentration (ppm) and $x = \text{sensor output voltage (mV)}$

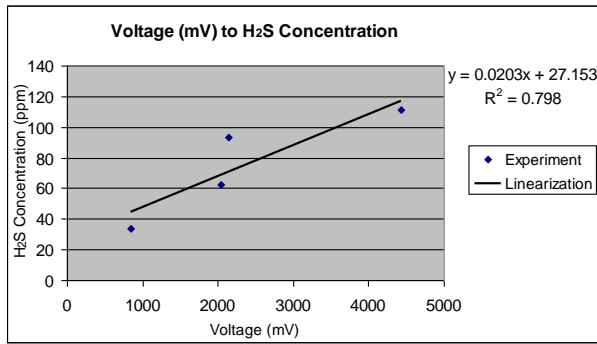

Figure 9. Linearization of Voltage to Concentration from Sensor Calibration

Filter Column Experiments

Filter column experiments comprise of filter column I with recycled BFA aggregate size 60 + 100 mesh and filter column II with recycled BFA aggregate size -200 mesh. Before data recording of biogas characteristic from the filter output is taken, initial H_2S concentration is measured by means of BBTKL sampling. The sampling result is given in Table 2.

Table 2. H_2S Sampling Result of Biogas Filter Input by BBTKL

No.	Biogas Filter Input Flow Rate	BBTKL H_2S Sampling Result (ppm)	Temperature ($^{\circ}\text{C}$)	RH (%)	Notes
1	0.5 L/m	117.73	30	82	Filter I Input
2	0.5 L/m	124.8	30	82	Filter II Input

The biogas output from the filter and sensor column is recorded by H_2S monitoring system through Delphi 7.0 IDE. The display of recorded data for filter column I and filter column II are given in Figure 10 and Figure 11 respectively.

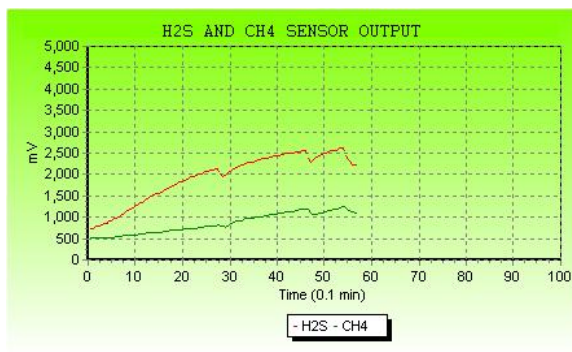

Figure 10. Recorded Data Display of H_2S Monitoring System of Filter Column I

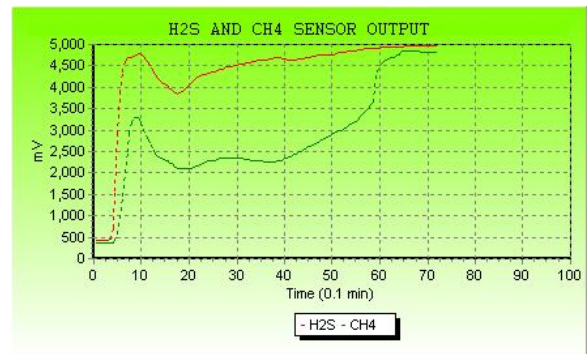

Figure 11. Recorded Data Display of H_2S Monitoring System of Filter Column II

Filter Column I

From the voltage outputs of Figure 11, linear equation of H_2S and CH_4 output voltage relative to time as seen in Figure 12 and Figure 13 respectively can be obtained.

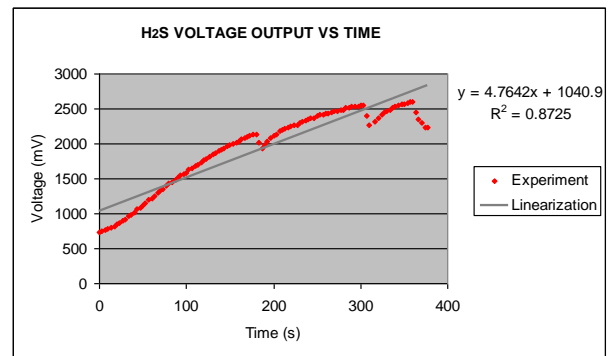

Figure 12. Linearization of H_2S Voltage Output Relative to Time

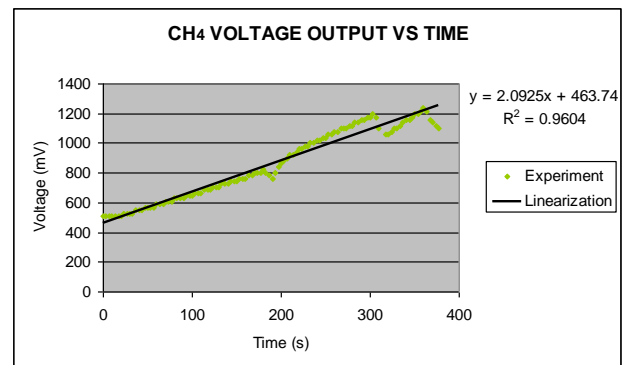

Figure 13. Linearization of CH_4 Voltage Output Relative to Time

Based on Figure 12 and Figure 13, linear equation of H_2S and CH_4 Voltage Output are equation (2) and equation (3) respectively.

$$y = 4.7642x + 1040.9 \dots\dots\dots(2)$$

$$y = 2.0925x + 463.74 \dots\dots\dots(3)$$

Where:

$y = \text{H}_2\text{S}/ \text{CH}_4$ voltage output (mV)

$x = \text{time (s)}$

Based on linear equation (1) of H₂S concentration (ppm) and H₂S output voltage (mV), conversion of H₂S sensor recorded data Figure 12 from H₂S voltage output to H₂S concentration can be obtained. Graphical data of the conversion is given in Figure 14.

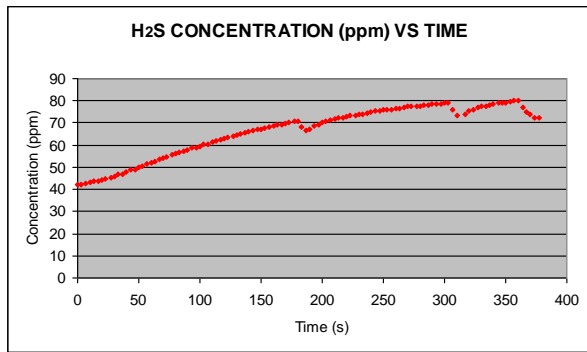

Figure 14. H₂S Concentration Relative to Time

According to Table 2, initial H₂S concentration of the filter input is 117.73 ppm. Thus, after 360 s or 6 minutes, BFA has not reached its saturation condition. The BFA saturation time can be analyzed in linearization model of H₂S concentration graphics from Figure 14. The linearization model comprises of Adam-Bohart's model, Thomas' model, and Yan's model, which are given in Figure 15, Figure 16 and Figure 17.

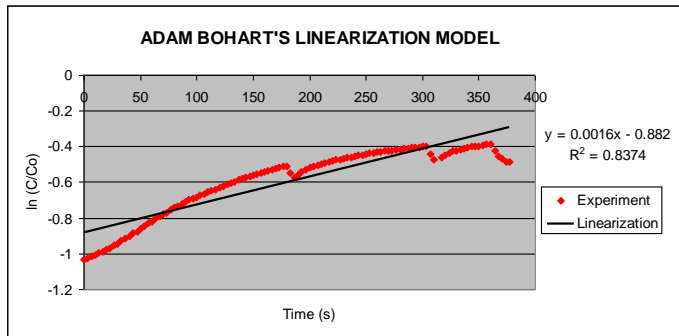

Figure 15. Adam Bohart's Linearization Model

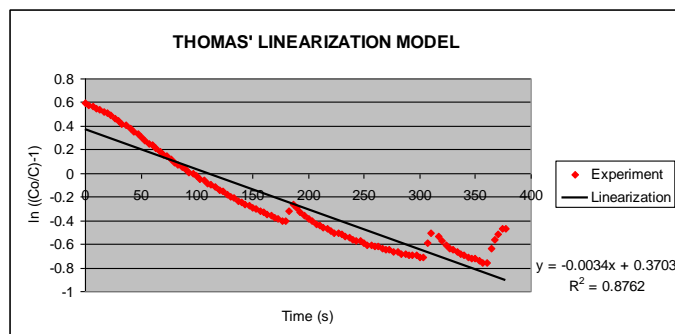

Figure 16. Thomas' Linearization Model

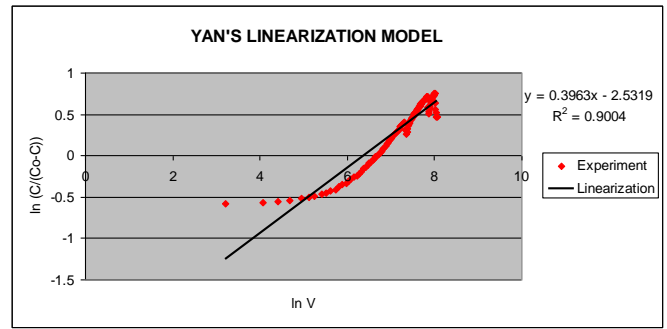

Figure 17. Yan's Linearization Model

Adam Bohart's, Thomas' and Yan's linearization equation obtained from Figure 15, Figure 16 and Figure 17 respectively are :

$$y = 0.0016x - 0.882 \quad \dots\dots\dots (4)$$

$$y = -0.0034x + 0.3703 \quad \dots\dots\dots (5)$$

$$y = 0.3963x - 2.5319 \quad \dots\dots\dots (6)$$

Furthermore, equation (4), equation (5) and equation (6) and also data from Table 2 is used to find out parameter k_{AB} , q_{AB} , k_{TH} , q_{TH} , k_Y , q_Y of the linearization models. Parameters obtained are given in Table 3.

Table 3. Parameters of Adam Bohart's, Thomas', and Yan's Linearization Model

Model	Co (mg/m L)	Q (mL/ s)	ρ (g/mL)	Kinetic Constant ($k_{AB}/k_{TH}/k_Y$) mL/mg/s	Capacity of Column ($q_{AB}/q_{TH} /q_Y$) mg/g	R ²
Adam Bohart	0.118	8.333	0.526	0.014	1.083	0.837
Thomas	0.118	8.333	0.526	0.029	0.214	0.876
Yan	0.118	8.333	0.526	28.052	0.354	0.900

Among three linearization model analyzed, the most appropriate model to represent experiment data of BFA size of 60+100 mesh is the model which has R² closest to value 1. It means that error between model equation and experiment data has the most minimum values. Based on Table 7, R² value closest to 1 is given by Yan's linearization model. Thus, the best model used for BFA size of 60+100 mesh is Yan's linearization model.

Filter Column II

From Figure 12, As time running on, both voltage outputs of H₂S and CH₄ sensors are increasing but after the first minute, both H₂S and CH₄ voltage outputs are decreasing again. It occurred due to temperature and humidity changes. Meanwhile, linear equation of H₂S and CH₄ output voltage relative to timewill be given for the first one minute of Figure 12 in Figure 18 and Figure 19.

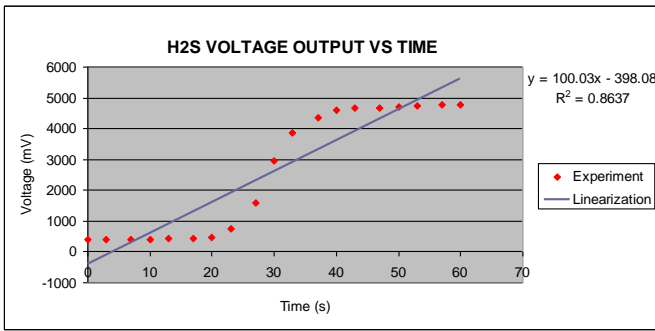

Figure 18. Linearization of H₂S Voltage Output Relative to Time

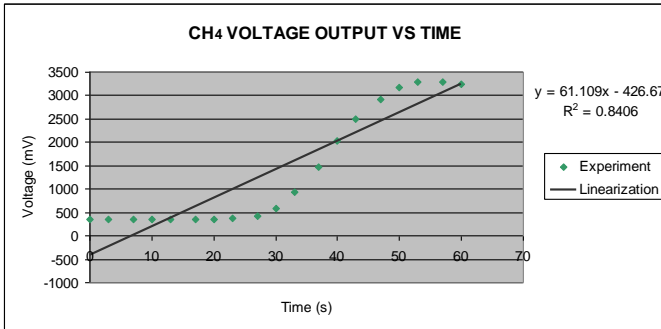

Figure 19. Linearization of CH₄ Voltage Output Relative to Time

Based on Figure 18 and Figure 19, linear equation of H₂S and CH₄ Voltage Output are equation (7) and equation (8) respectively.

$$y = 100.03x - 398.08 \dots\dots\dots (7)$$

$$y = 61.109x - 426.67 \dots\dots\dots (8)$$

Where:

y = H₂S/ CH₄ voltage output (mV)

x = time (s)

Based on linear equation (1) of H₂S concentration (ppm) and H₂S output voltage (mV), conversion of H₂S sensor recorded data Figure 18 from H₂S voltage output to H₂S concentration can be obtained. Graphical data of the conversion is given in Figure 20.

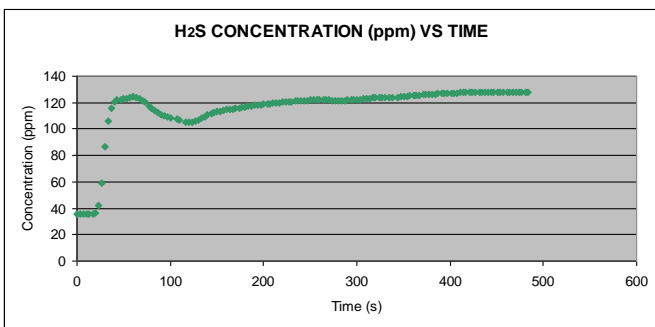

Figure 20. H₂S Concentration Relative to Time

According to Table 2, initial H₂S concentration of biogas filter input is 124.8 ppm. As seen in Figure 20, H₂S concentration in the filter output is increasing from its initial starting time at 35.51 ppm up to 124.28 ppm or at 60 s. It means that BFA has reached its saturation condition several moments after 60 s. From 60 s, H₂S concentration value is decreasing up to 127 s and increasing again

afterward. According to recorded data table obtained from the Delphi software, after BFA reaching its saturation condition at 60 s, temperature and relative humidity changes has occurred. Since the sensor output value is sensitive to humidity, although BFA has experienced saturation condition, H₂S concentration tends to decrease. Thus, the linearization model will merely be analyzed from initial time up to saturation time at 60 s. Adam Bohart's, Thomas', and Yan's linearization model of H₂S concentration graph in Figure 20 are given in Figure 21, Figure 22, and Figure 23 respectively.

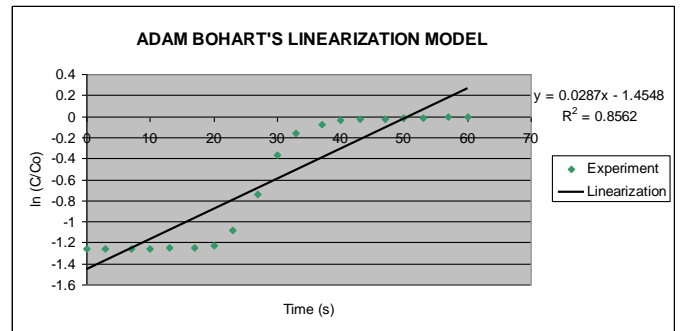

Figure 21. Adam Bohart's Linearization Model

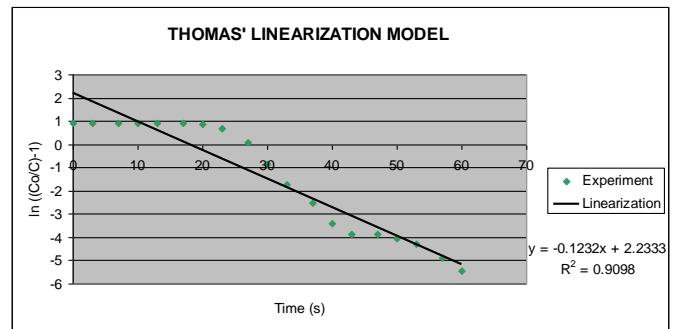

Figure 22. Thomas' Linearization Model

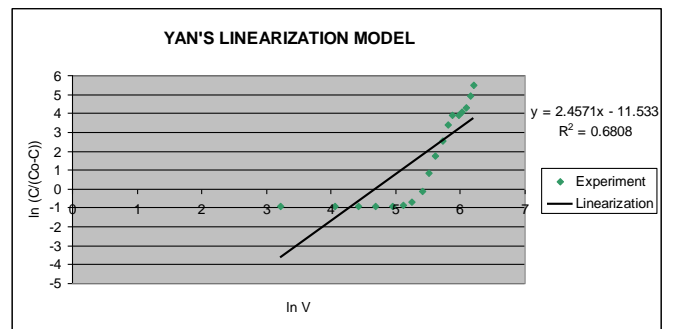

Figure 23. Yan's Linearization Model

Adam Bohart's, Thomas' and Yan's linearization equation obtained from Figure 21, Figure 22 and Figure 23 respectively are :

$$y = 0.0287x - 1.4548 \dots\dots\dots (9)$$

$$y = -0.1232x + 2.2333 \dots\dots\dots (10)$$

$$y = 2.4571x - 11.533 \dots\dots\dots (11)$$

Furthermore, equation (9), equation (10) and equation (11) and also data from Table 2 is used to find out parameter k_{AB} , q_{AB} , k_{TH} , q_{TH} , k_Y , q_Y of the linearization models. Parameters obtained are given in Table 4.

Table 4. Parameters of Adam Bohart's, Thomas', and Yan's Linearization Model

Model	Co (mg/mL)	Q (mL/s)	ρ (g/mL)	Kinetic Constant ($k_{AB}/k_{TH}/k_y$) mL/mg/s	Capacity of Column ($q_{AB}/q_{TH}/q_y$) mg/g	R ²
Adam Bohart	0.125	8.33	0.526	0.230	0.106	0.8562
Thomas	0.125	8.33	0.526	0.987	0.038	0.9098
Yan	0.125	8.33	0.526	164.069	0.011	0.6808

Among three linearization model analyzed, the most appropriate model to represent experiment data of BFA size of -200 mesh is the model which has R² closest to value 1. Based on Table 4.4 , R² value closest to 1 is given by Thomas' linearization model. Thus, the best model used for BFA size of -200 mesh is Thomas' linearization model.

Analysis of Adsorption Capacity

From the analysis result of the best model for each BFA sizes, the best model which represents both BFA sizes can be chosen. According to AksudanGosen (2004), Thomas model is a solution that generally and widely used to solve column performance theory. Although the best model represents BFA size of -60+100 mesh is Yan's model, according to Sarwono (2006), Thomas model is considered to have a strong correlation since its R² > 0.5 (RizkyTrianaPutri, 2012).

Adsorption capacity obtained from Thomas model in Table 3 and Table 4 for each BFA sizes is represented by q_{th}. The description can be seen in Table 5.

Table 5. Adsorption Capacity of BFA Variable Sizes

BFA Size (mesh)	Initial Concentration (ppm)	Flow Rate (L/m)	Adsorption Capacity (mg/g)
-60+100	117.73	0.5	0.214
-200	125.8	0.5	0.038

Based on Table 5, it can be concluded that q_{-60+100 mesh} > q_{-200 mesh}. Although BFA size of -200 mesh has smaller particle size than BFA size of -60+100 mesh, the initial H₂S concentration of BFA size of -200 mesh is bigger than initial concentration of H₂S concentration of BFA size of -60+100 mesh. A change in the inlet sorbet concentration affected the operating characteristics of the column. At low initial concentration, breakthrough occurred late and the treated volume is higher since the lower concentration gradient caused a slower transport due to decreased diffusion coefficient or mass transfer coefficient. The adsorbent gets saturated early at high initial concentration because

binding sites become more quickly saturated in the system (Aksu and Gonen, 2004 in RizkyTrianaPutri, 2012).

4. Conclusions

Based on result and analysis of the research, conclusions obtained are given below:

- 1) Sensor characteristic experiments show that warming up time for H₂S and CH₄ sensor is 32 minutes and 41 seconds respectively. Generally, sensor response time for both H₂S and CH₄ sensors is less than 1 s.
- 2) Based on sensor calibration experiment, sensor output voltage is proportional with H₂S concentration. The larger sensor output voltage, the larger H₂S concentration.
- 3) Linearization of TGS825 sensor calibration result in following equation :

$$y = 0.0203x + 27.153$$

Where y = H₂S concentration (ppm) and x = sensor output voltage (mV)

- 4) Filter column I with BFA size of 60+100 mesh experiments give result :
 - a. Linear equation of H₂S and CH₄ Voltage Output

$$y = 4.7642x + 1040.9$$

Where y = H₂S voltage output (mV) and x = time (s)

$$y = 2.0925x + 463.74$$

Where y = CH₄ voltage output (mV) and x = time (s)

- 5) Filter column II with BFA size of -200 mesh experiments give result :
 - b. The best model used for BFA size of 60+100 mesh is Yan's linearization model with R² = 0.9004 and parameter k_y = 28.052 and q_y = 0.354, where k_y = Yan Kinetic Constant (mL/mg/s) and q_y = capacity of column (mg/g)

- 6) Filter column I with BFA size of -200 mesh experiments give result :
 - a. Linear equation of H₂S and CH₄ Voltage Output

$$y = 100.03x - 398.08$$

Where y = H₂S voltage output (mV) and x = time (s)

$$y = 61.109x - 426.67$$

Where y = CH₄ voltage output (mV) and x = time (s)

- 7) The best model used for BFA size of -200 mesh is Thomas' linearization model with R² = 0.9098 and parameter k_{TH} = 0.987 and q_{TH} = 0.038 , where k_{TH} = Thomas Kinetic Constant (mL/mg/s) and q_{TH} = capacity of column (mg/g)
- 8) The best model which represents BFA adsorption of biogas from tofu waste in the research is Thomas model. Besides generally and widely used to solve column performance theory, Thomas model in the research is considered to have a strong correlation since its R² > 0.5.
- 9) Adsorption capacity of BFA size of -60+100 mesh is higher that adsorption capacity of BFA size of -200

mesh due to higher initial concentration of BFA size of -200 mesh compare to BFA size of -60+100 mesh.

References

- ATMEL AVR ATMEGA8535 Microcontroller Datasheet.
- Danarto, YC. and Samun T, *Pengaruh Aktivasi Karbon Dari Sekam Padi Pada Proses Adsorpsi Logam Cr (VI)*, Chemical Engineering Department, UNS, Surakarta
- Figaro TGS2611 Sensor Datasheet.
- Figaro TGS825 Special Sensor for Hydrogen Sulfide Datasheet.
- Goendi, S., Tri Purwadi, et al, 2008, *Kajian Model Digester Limbah Cair Tahu Untuk Produksi Biogas Berdasarkan Waktu Penguraian*. Proceeding on National Seminar of Agriculture Engineering 2008, Yogyakarta
- Jayanti, Arfini Dwi, 2011, *Perancangan Instrumen Untuk Deteksi Gas Hidrogen Sulfida*, Bachelor Final Project Report in Physics Department, ITS, Surabaya
- Maulidiah, N.L.I, 2010, *Akuisisi Data Sistem Sensor Gas Pada Sistem Produksi Biogas*, Bachelor Final Project Report in Physics Department, ITS, Surabaya
- Resbiantoro, Gaguk, 2011, *Perancangan dan Pembuatan Sistem Monitoring Biogas*, Bachelor Final Project Report in Physics Department, ITS, Surabaya
- Triana Putri, Rizki, 2012, *Bagasse Fly Ash Utilization As an Absorbent to Reduce H₂S Level In Tofu Waste Biogas*, Thesis in Master Program of System Engineering, Postgraduate Program, GadjahMada University, Yogyakarta
- Wardani, R.K, 2010, *Penentuan Waktu Tinggal Optimum Return Sludge Terhadap Peningkatan Produksi Biogas dan Konsentrasi Gas Metana Pada Biodigester Dengan Bahan Kotoran Sapi*, M.Eng. Thesis in Master of Engineering System, Gadjah Mada University, Yogyakarta
- Zicari, S.M, 2003, *Removal Of Hydrogen Sulfide From Biogas Using Cow-Manure Compost*, M.Sc. Thesis in Faculty of The Graduate School, Cornell University, Ithaca, NY: 1p